

# SPC-7000/7100/7200 USER Manual

Intel® Core™ i7/i5/i3 (Tiger Lake) Ultra-Compact Fanless Embedded System  
1 GigE LAN, 1 2.5G GigE LAN, 10G USB, 2 COM, 9V to 55V, -40°C to 75°C

## Record of Revision

---

Version	Date	Page	Description	Remark
1.00	2021/03/29	All	Official Release	
1.10	2021/05/11	3, 5, 7	Update	
1.20	2021/07/26	50	Update	
1.30	2021/08/13	1	Update	
1.40	2021/10/27	4	Update	
1.50	2022/06/24	25	Update	
1.60	2023/02/17	37, 70, 78	Update	
1.70	2023/05/17	12, 41, 43	Update	
1.80	2024/02/26	27	Update	

# Disclaimer

This manual is released by Vecow Co., Ltd. for reference purpose only. All product offerings and specifications are subject to change without prior notice. It does not represent commitment of Vecow Co., Ltd. Vecow shall not be liable for direct, indirect, special, incidental, or consequential damages arising out of the use of the product or documentation or any infringements upon the rights of third parties, which may result from such use.

# Declaration of Conformity

**FCC** This equipment has been tested and found to comply with the limits for a Class A digital device, pursuant to part 15 of the FCC Rules. These limits are designed to provide reasonable protection against harmful interference when the equipment is operated in a commercial environment. This equipment generates, uses, and can radiate radio frequency energy, and if it is not installed and used in accordance with the instruction manual, it may cause harmful interference to radio communications. Operation of this equipment in a residential area is likely to cause harmful interference in which case the user will be required to correct the interference at his own expense.

**CE** The products described in this manual complies with all applicable European Union (CE) directives if it has a CE marking. For computer systems to remain CE compliant, only CE-compliant parts may be used. Maintaining CE compliance also requires proper cable and cabling techniques.

# Copyright and Trademarks

This document contains proprietary information protected by copyright. No part of this publication may be reproduced in any form or by any means, electric, photocopying, recording or otherwise, without prior written authorization by Vecow Co., Ltd. The rights of all the brand names, product names, and trademarks belong to their respective owners.

# Order Information

Part Number	Description	GigE LAN	2.5G LAN	10G USB	COM	SIM Socket	SSD Bracket	CPU TDP	Thermal Solution
SPC-7000-1185G7E	i7-1185G7E	1	1	2	2	1	1	12W, 15W	Heat Spreader
SPC-7000-1145G7E	i5-1145G7E								
SPC-7100-1185G7E	i7-1185G7E							12W, 15W	Heat Sink
SPC-7100-1145G7E	i5-1145G7E								
SPC-7200-1185G7E	i7-1185G7E							28W	Fan Sink
SPC-7200-1145G7E	i5-1145G7E								



## Optional Accessories

---

Part Number	Description
DDR4 32G	Certified DDR4 32GB 3200MHz RAM
DDR4 16G	Certified DDR4 16GB 3200MHz RAM
DDR4 8G	Certified DDR4 8GB 3200MHz RAM
DDR4 4G	Certified DDR4 4GB 3200/2666/2400 MHz RAM
VESA Mount	VESA Mounting Kit
DIN-RAIL	DIN Rail Kit
PWA-120W	120W, 24V, 90V AC to 264V AC Power Adapter with 3-pin Terminal Block
4G Module	4G/GPS Module with Antenna
5G Module	5G Module with Antenna
WiFi & Bluetooth Module	WiFi & Bluetooth Module with Antenna

# Table of Contents

<b>CHAPTER 1</b>	<b>GENERAL INTRODUCTION</b>	<b>1</b>
1.1	Overview	1
1.2	Features	2
1.3	Product Specification	3
1.3.1	Specifications of SPC-7000	3
1.3.2	Specifications of SPC-7100	5
1.3.3	Specifications of SPC-7200	7
1.4	Supported CPU List	9
1.5	Mechanical Dimension	10
1.5.1	SPC-7000 Mechanical Drawing	10
1.5.2	SPC-7100 Mechanical Drawing	10
1.5.3	SPC-7200 Mechanical Drawing	11
<b>CHAPTER 2</b>	<b>GETTING TO KNOW YOUR SPC-7000</b>	<b>12</b>
2.1	SPC-7000/7100/7200 Packing List	12
2.2	Front Panel I/O & Functions	13
2.3	Rear Panel I/O & Functions	17
2.4	Connector/Jumper Locations	19
2.5	Main Board Jumper Settings	39
2.6	Ignition Control	42
<b>CHAPTER 3</b>	<b>SYSTEM SETUP</b>	<b>45</b>
3.1	How to Open Your SPC-7000	45
3.2	Installing DDR4 SO-DIMM Module	46
3.3	Installing M.2	47
3.4	Installing SSD/HDD	49
3.5	Installing SIM Card	50
3.6	Installing Antenna Cable	51
3.7	Mounting Your SPC-7000	52

<b>CHAPTER 4</b>	<b>BIOS SETUP</b>	<b>53</b>
4.1	BIOS Setting	53
4.2	Main Menu	54
4.3	Advanced Functions	54
4.4	Chipset Functions	67
4.5	Security	74
4.6	Boot Functions	76
4.7	Save & Exit	77
<b>APPENDIX A</b>	<b>: GPIO GUIDE</b>	<b>78</b>
<b>APPENDIX B</b>	<b>: Software Functions</b>	<b>81</b>
<b>APPENDIX C</b>	<b>: RAID Functions</b>	<b>84</b>
<b>APPENDIX D</b>	<b>: Power Consumption</b>	<b>94</b>
<b>APPENDIX E</b>	<b>: Supported Memory &amp; Storage List</b>	<b>97</b>

# 1

## GENERAL INTRODUCTION

### 1.1 Overview

SPC-7000/7100/7200 is an Ultra-compact Embedded Box PC. Powered by 11th Gen Intel® Core™ i7/i5/i3 Processor and runs on Intel® SoC with 28W TDP supported delivering up to 22% faster CPU performance than the previous generation, Vecow SPC-7000/7100/7200 delivers high-performance computing and real-time capabilities for critical Industrial IoT deployment.

This ultra-compact embedded Box PC includes 32GB of DDR4 3200MHz memory and features advanced Intel® Iris® Xe graphics, enabling dual DisplayPort displays with 4K Resolution. Available across high-speed connectivity such as USB (10G), and GigE LAN (2.5G), SPC-7000/7100/7200 is capable of supporting demanding AI-enabled workloads in a wide range of industrial use cases.

Vecow SPC-7000/7100/7200 provides a wide range of I/O interfaces including 1 GigE LAN, 2.5GigE LAN, 4 USB, 2 COM, as well as 1 SIM card socket. It has 1 SATA III and 1 M.2 Key B for storage. In addition, it provides M.2 socket to support 5G/WiFi 6/4G/LTE/GPRS/UMTS wireless networks and SUMIT A, B (optional) socket for 10G LAN, 10G SFP+, 5G, SIM socket, PoE+, Series port and video capture expansion. The system features -40°C to 85°C extended operating temperature, 9V to 55V DC-in, as well as ignition power control to allow the deployment of industrial applications in harsh industrial environments and is ideal for Factory Automation, Service Robot, Cellular V2X, Smart Retail and any AIoT/Industry 4.0 applications.

## 1.2 Features

- 11th Gen Intel® Core™ i7/i5/i3 processor (Tiger Lake UP3) delivers new generation system productivity than ever, up to 28W TDP
- Compact design, up to -40°C to 75°C operating temperature
- DDR4 3200MHz memory, up to 32GB
- Dual DisplayPort display, up to 4K resolution
- Multiple USB supports up to 10Gbps data transfer
- 1 Independent 2.5GigE LAN supports Intel® Time Sensitive Networking (TSN) for real-time data synchronization
- 1 GigE LAN supports iAMT, TPM 2.0 supported
- 9V to 55V wide range DC Power Input, Ignition Control
- SIM Socket for 5G/WiFi/4G/3G/LTE/GPRS/UMTS
- Optional supports full function SUMIT A, B expansions for multiple 10GigE LAN, 10G SFP+, 5G Network, SIM Socket, PoE LAN, Serial Port, GigE LAN, Fiber LAN, or Video Capture
- Optional VHub One-Stop AIoT Solution Service supports OpenVINO based AI accelerator and advanced Edge AI applications

## 1.3 Product Specification

### 1.3.1 Specifications of SPC-7000

<b>System</b>	
Processor	Quad Core Intel® Core™ i7/i5/i3 U-series Processor (Tiger Lake UP3)
Chipset	Intel® SoC (Tiger Lake)
BIOS	AMI
SIO	IT8786E
Memory	1 DDR4 3200MHz SO-DIMM, up to 32GB
<b>Graphics</b>	
Graphics Processor	Intel® Iris® X <sup>e</sup> Graphics
Interface	<ul style="list-style-type: none"> <li>• DisplayPort 1 : Up to 4096 x 2304 @60Hz</li> <li>• DisplayPort 2 : Up to 4096 x 2304 @60Hz</li> </ul>
<b>Ethernet</b>	
LAN 1	Intel® I219LM GigE LAN supports iAMT
LAN 2	Intel® I225-IT supports 2.5 GigE LAN
<b>Audio</b>	
Audio Codec	Realtek ALC888S-VD, 7.1 Channel HD Audio
Audio Interface	1 Mic-in, 1 Line-out
<b>Storage</b>	
SATA	1 SATA III (6Gbps)
M.2	1 M.2 Key B 2260 Socket (Same socket as M.2 Key B for expansion)
<b>I/O Interface</b>	
Serial	2 COM RS-232/422/485 (ESD 8kV)
USB	<ul style="list-style-type: none"> <li>• 2 USB 3.1 (External)</li> <li>• 2 USB 2.0 (External)</li> <li>• 2 USB 2.0 (Internal)</li> </ul>
LED	Power, HDD, WWAN, WLAN
SIM Card	1 Nano SIM Card Socket (External)
<b>Expansion</b>	
M.2	2 M.2 sockets : <ul style="list-style-type: none"> <li>• 1 M.2 Key B Socket (3042/3052)</li> <li>• 1 M.2 Key E Socket (2230)</li> </ul>
SUMIT	<ul style="list-style-type: none"> <li>• 1 SUMIT A Connector</li> <li>• 1 SUMIT B Connector</li> </ul>
<b>Power</b>	
Power Input	9V to 55V DC-in
Power Interface	3-pin Terminal Block : V+, V-, Frame Ground
Remote Switch	2-pin Terminal Block

<b>Others</b>	
TPM	Optional Infineon SLB 9670VQ2.0FW7.85 supports TPM 2.0, SPI Interface
Watchdog Timer	Reset : 1 to 255 sec./min. per step
HW Monitor	Monitoring temperature, voltages. Auto throttling control when CPU overheats.
Ignition Control	16 Mode (Internal)
<b>Software Support</b>	
OS	Windows 10, Linux
<b>Mechanical</b>	
Dimension (W x L x H)	150.4mm x 106.2mm x 44.0mm (5.92" x 4.18" x 1.73")
Weight	0.9 kg (1.98 lb)
Mounting	<ul style="list-style-type: none"> <li>• Wallmount by mounting bracket</li> <li>• DIN Rail Mount (Optional)</li> <li>• VESA Mount (Optional)</li> </ul>
<b>Environment</b>	
Operating Temperature	-40°C to 60°C (-40°F to 140°F) at 15W TDP CPU
Storage Temperature	-40°C to 85°C (-40°F to 185°F)
Humidity	5% to 95% Humidity, non-condensing
Relative Humidity	95% at 75°C
Shock	<ul style="list-style-type: none"> <li>• IEC 60068-2-27</li> <li>• SSD : 50G @wallmount, Half-sine, 11ms</li> </ul>
Vibration	<ul style="list-style-type: none"> <li>• IEC 60068-2-64</li> <li>• SSD : 5Grms, 5Hz to 500Hz, 3 Axis</li> </ul>
EMC	CE, FCC, EN50155, EN50121-3-2

### 1.3.2 Specifications of SPC-7100

<b>System</b>	
Processor	Quad Core Intel® Core™ i7/i5/i3 U-series Processor (Tiger Lake UP3)
Chipset	Intel® SoC (Tiger Lake)
BIOS	AMI
SIO	IT8786E
Memory	1 DDR4 3200MHz SO-DIMM, up to 32GB
<b>Graphics</b>	
Graphics Processor	Intel® Iris® X <sup>e</sup> Graphics
Interface	<ul style="list-style-type: none"> <li>• DisplayPort 1 : Up to 4096 x 2304 @60Hz</li> <li>• DisplayPort 2 : Up to 4096 x 2304 @60Hz</li> </ul>
<b>Ethernet</b>	
LAN 1	Intel® I219LM GigE LAN supports iAMT
LAN 2	Intel® I225-IT supports 2.5 GigE LAN
<b>Audio</b>	
Audio Codec	Realtek ALC888S-VD, 7.1 Channel HD Audio
Audio Interface	1 Mic-in, 1 Line-out
<b>Storage</b>	
SATA	1 SATA III (6Gbps)
M.2	1 M.2 Key B 2260 Socket (Same socket as M.2 Key B for expansion)
<b>I/O Interface</b>	
Serial	2 COM RS-232/422/485 (ESD 8kV)
USB	<ul style="list-style-type: none"> <li>• 2 USB 3.1 (External)</li> <li>• 2 USB 2.0 (External)</li> <li>• 2 USB 2.0 (Internal)</li> </ul>
LED	Power, HDD, WWAN, WLAN
SIM Card	1 Nano SIM Card Socket (External)
<b>Expansion</b>	
M.2	2 M.2 sockets : <ul style="list-style-type: none"> <li>• 1 M.2 Key B Socket (3042/3052)</li> <li>• 1 M.2 Key E Socket (2230)</li> </ul>
SUMIT	<ul style="list-style-type: none"> <li>• 1 SUMIT A Connector</li> <li>• 1 SUMIT B Connector</li> </ul>
<b>Power</b>	
Power Input	9V to 55V DC-in
Power Interface	3-pin Terminal Block : V+, V-, Frame Ground
Remote Switch	2-pin Terminal Block



<b>Others</b>	
TPM	Optional Infineon SLB 9670VQ2.0FW7.85 supports TPM 2.0, SPI Interface
Watchdog Timer	Reset : 1 to 255 sec./min. per step
HW Monitor	Monitoring temperature, voltages. Auto throttling control when CPU overheats.
Ignition Control	16 Mode (Internal)
<b>Software Support</b>	
OS	Windows 10, Linux
<b>Mechanical</b>	
Dimension (W x L x H)	150.4mm x 106.2mm x 57.0mm (5.92" x 4.18" x 2.24")
Weight	1.3 kg (2.87 lb)
Mounting	<ul style="list-style-type: none"> <li>• Wallmount by mounting bracket</li> <li>• DIN Rail Mount (Optional)</li> <li>• VESA Mount (Optional)</li> </ul>
<b>Environment</b>	
Operating Temperature	-40°C to 75°C (-40°F to 167°F) at 15W TDP CPU
Storage Temperature	-40°C to 85°C (-40°F to 185°F)
Humidity	5% to 95% Humidity, non-condensing
Relative Humidity	95% at 75°C
Shock	<ul style="list-style-type: none"> <li>• IEC 60068-2-27</li> <li>• SSD : 50G @wallmount, Half-sine, 11ms</li> </ul>
Vibration	<ul style="list-style-type: none"> <li>• IEC 60068-2-64</li> <li>• SSD : 5Grms, 5Hz to 500Hz, 3 Axis</li> </ul>
EMC	CE, FCC, EN50155, EN50121-3-2

### 1.3.3 Specifications of SPC-7200

<b>System</b>	
Processor	Quad Core Intel® Core™ i7/i5/i3 U-series Processor (Tiger Lake UP3)
Chipset	Intel® SoC (Tiger Lake)
BIOS	AMI
SIO	IT8786E
Memory	1 DDR4 3200MHz SO-DIMM, up to 32GB
<b>Graphics</b>	
Graphics Processor	Intel® Iris® X <sup>e</sup> Graphics
Interface	<ul style="list-style-type: none"> <li>• DisplayPort 1 : Up to 4096 x 2304 @60Hz</li> <li>• DisplayPort 2 : Up to 4096 x 2304 @60Hz</li> </ul>
<b>Ethernet</b>	
LAN 1	Intel® I219LM GigE LAN supports iAMT
LAN 2	Intel® I225-IT supports 2.5 GigE LAN
<b>Audio</b>	
Audio Codec	Realtek ALC888S-VD, 7.1 Channel HD Audio
Audio Interface	1 Mic-in, 1 Line-out
<b>Storage</b>	
SATA	1 SATA III (6Gbps)
M.2	1 M.2 Key B 2260 Socket (Same socket as M.2 Key B for expansion)
<b>I/O Interface</b>	
Serial	2 COM RS-232/422/485 (ESD 8kV)
USB	<ul style="list-style-type: none"> <li>• 2 USB 3.1 (External)</li> <li>• 2 USB 2.0 (External)</li> <li>• 2 USB 2.0 (Internal)</li> </ul>
LED	Power, HDD, WWAN, WLAN
SIM Card	1 Nano SIM Card Socket (External)
<b>Expansion</b>	
M.2	2 M.2 sockets : <ul style="list-style-type: none"> <li>• 1 M.2 Key B Socket (3042/3052)</li> <li>• 1 M.2 Key E Socket (2230)</li> </ul>
SUMIT	<ul style="list-style-type: none"> <li>• 1 SUMIT A Connector</li> <li>• 1 SUMIT B Connector</li> </ul>
<b>Power</b>	
Power Input	9V to 55V DC-in
Power Interface	3-pin Terminal Block : V+, V-, Frame Ground
Remote Switch	2-pin Terminal Block

<b>Others</b>	
TPM	Optional Infineon SLB 9670VQ2.0FW7.85 supports TPM 2.0, SPI Interface
Watchdog Timer	Reset : 1 to 255 sec./min. per step
HW Monitor	Monitoring temperature, voltages. Auto throttling control when CPU overheats.
Ignition Control	16 Mode (Internal)
<b>Software Support</b>	
OS	Windows 10, Linux
<b>Mechanical</b>	
Dimension (W x L x H)	150.4mm x 106.2mm x 59.9mm (5.92" x 4.18" x 2.36")
Weight	1.4 kg (3.09 lb)
Mounting	<ul style="list-style-type: none"> <li>• Wallmount by mounting bracket</li> <li>• DIN Rail Mount (Optional)</li> <li>• VESA Mount (Optional)</li> </ul>
<b>Environment</b>	
Operating Temperature	-40°C to 70°C (-40°F to 158°F) at 28W TDP CPU with Fan
Storage Temperature	-40°C to 85°C (-40°F to 185°F)
Humidity	5% to 95% Humidity, non-condensing
Relative Humidity	95% at 75°C
Shock	<ul style="list-style-type: none"> <li>• IEC 60068-2-27</li> <li>• SSD : 50G @wallmount, Half-sine, 11ms</li> </ul>
Vibration	<ul style="list-style-type: none"> <li>• IEC 60068-2-64</li> <li>• SSD : 5Grms, 5Hz to 500Hz, 3 Axis</li> </ul>
EMC	CE, FCC, EN50155, EN50121-3-2

## 1.4 Supported CPU List

Processor No.	Cores	TDP	Cache	Max. Frequency	ECC Memory
Intel® Core™ i7-1185G7E	4	28W	12M	Up to 4.4GHz	N
Intel® Core™ i5-1145G7E	4	28W	8M	Up to 4.1GHz	N

# 1.5 Mechanical Dimension

## 1.5.1 SPC-7000 Mechanical Drawing

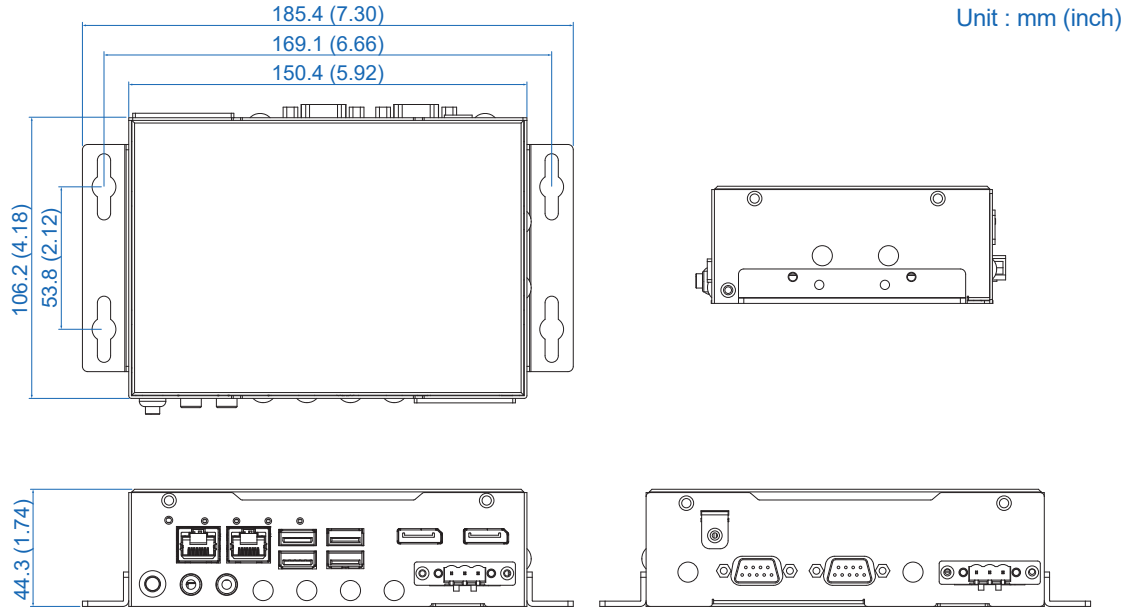

## 1.5.2 SPC-7100 Mechanical Drawing

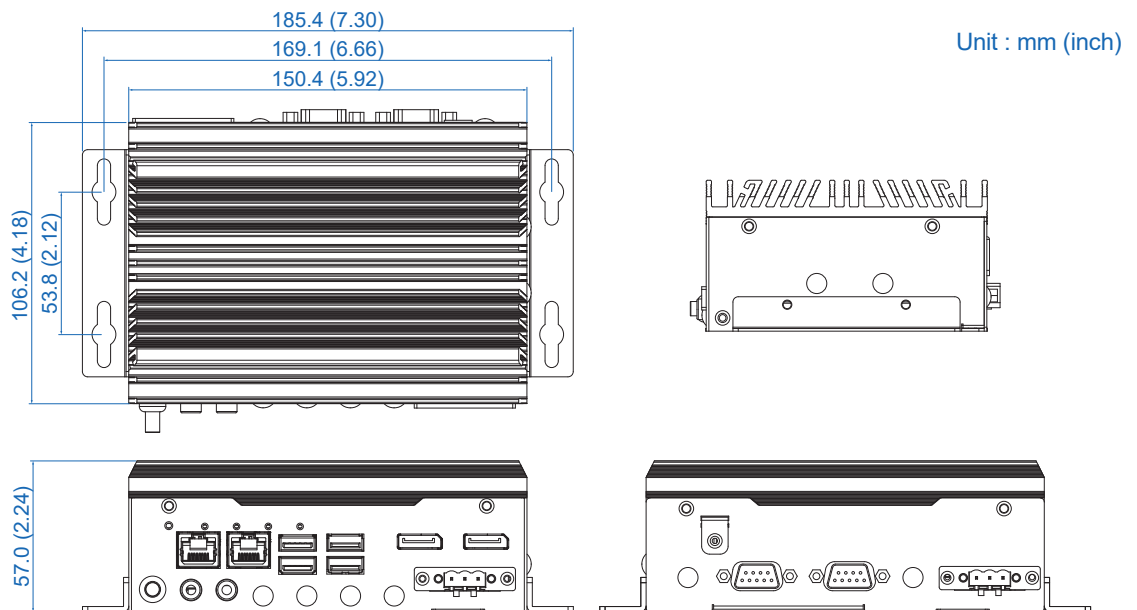

### 1.5.3 SPC-7200 Mechanical Drawing

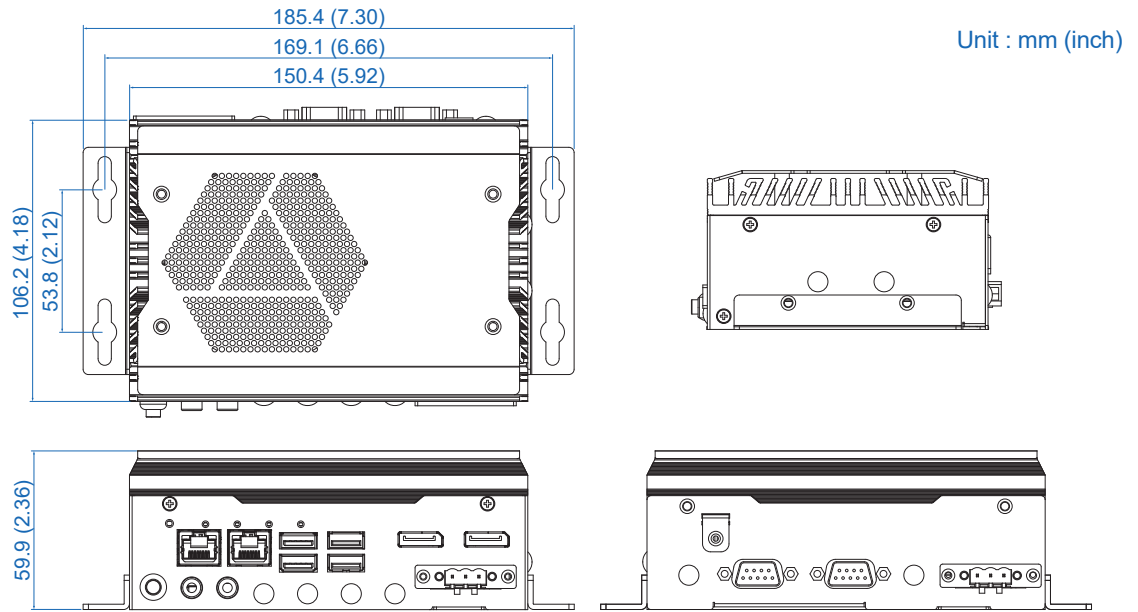



# 2

## GETTING TO KNOW YOUR SPC-7000

### 2.1 SPC-7000/7100/7200 Packing List

Item	Description	Qty
1	SPC-7000/7100/7200 Embedded System	1

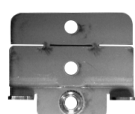
Item	Description	Outlook	Usage	P/N	Qty
1	PHILLPIS M4x16L with washer, Ni		Mount	53-24D6416-30B	4
2	PHILLPIS M3*4L		M.2	53-2426204-80B	3
3	Wall-mounting bracket		Mount	62-01P0672-800	2
4	Terminal block plug pitch 5.0mm 3-pin		DC IN/Switch	51-2211R03-S1A	2
5	Foot Pad		Foot Pad	53-4000042-303	4
6	Flat M3x4L, Ni		Wall mount bracket	53-2466204-30B	8
7	M.2 Tray		M.2	62-01P0669-400	1

## 2.2 Front Panel I/O & Functions

### 2.2.1 SPC-7000/7100/7200 Front I/O & Functions

In Vecow's SPC-7000/7100/7200 series family, all I/O connectors are located on the front panel. Most of the general connections to the computer device, such as Audio, USB3.2, USB 2.0, LAN Jack, and Display Port, are placed on the front panel.

### 2.2.2 Reset Tact Switch

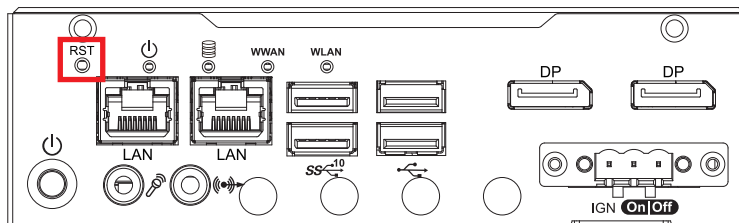

It is a hardware reset switch. Use this switch to reset the system without power off the system. Press the Reset Switch for a few seconds, then reset will be enabled.

### 2.2.3 Power Button

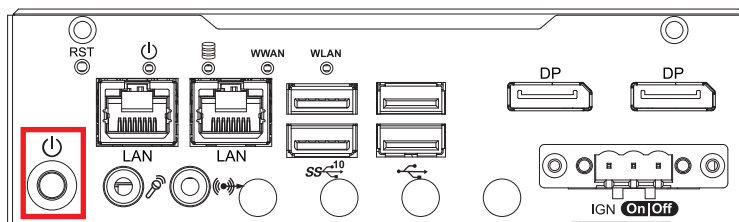

The power button is a non-latched switch. In case of system halts, you can press and hold the power button for 4 seconds to compulsorily shut down the system. Please note that a 4 seconds interval is kept by the system between two on/off operations (i.e. once turning off the system, you shall wait for 4 seconds to initiate another power-on operation).



## 2.2.4 PWR, HDD, WWAN, WLAN LED Indicator

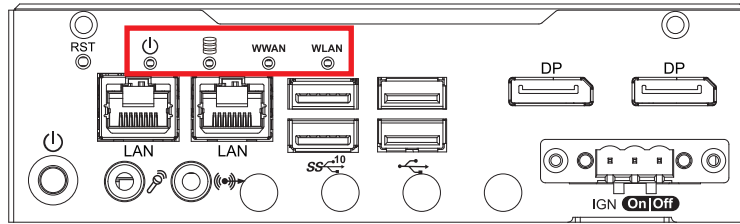

**Yellow-HDD LED** : A hard disk LED. If the LED is on, it indicates that the system's storage is functional. If it is off, it indicates that the system's storage is not functional. If it is flashing, it indicates data access activities are in progress.

**Green-Power LED** : If the LED is solid green, it indicates that the system is powered on.

**Green-WWAN LED** : If the LED is solid green, it indicates that the device on M2 key-B Socket is working.

**Green-WLAN LED** : If the LED is solid green, it indicates that the device on M2 key-E Socket is working.

LED Color	Indication	System Status
Yellow	HDD	<ul style="list-style-type: none"> <li>On/Off : Storage is functional or not</li> <li>2.Twinkling : Data transferring</li> </ul>
Green	POWER	System power is on or off
Green	WWAN	Device is working or not
Green	WLAN	Device is working or not

## 2.2.5 DisplayPorts

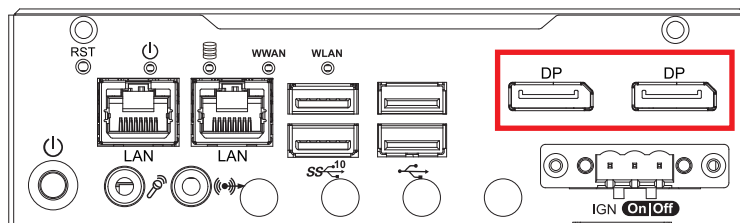

DisplayPort connection supports up to 4096 x 2304 resolution at 60Hz.

## 2.2.6 USB 3.2 Gen2

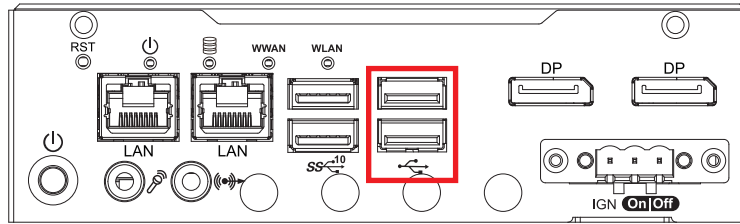

There are 2 USB 3.2 Gen2 ports connection available supporting up to 10GB per second data rate in the front side of SPC-7000/7100/7200. It also compliant with the requirements of Super Speed (SS), high speed (HS), full speed (FS) and low speed (LS).

## 2.2.7 USB 2.0

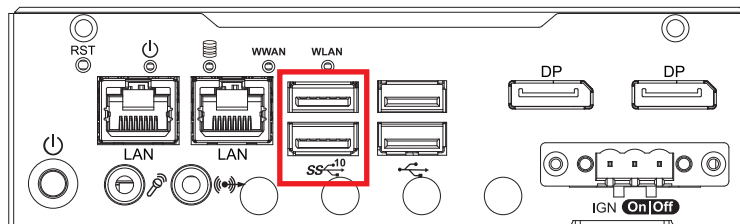

There are 2 USB 2.0 ports available supporting up to 480MB per second data rate in the front side of SPC-7000/7100/7200. They are also compliant with the requirements of high speed (HS), full speed (FS) and low speed (LS).

## 2.2.8 Audio Jack

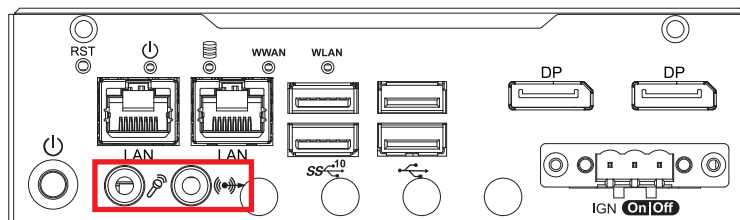

There are 2 audio connectors, Mic-in and Line-out, in the front side of SPC-7000/7100/7200. Onboard Realtek ALC888S-VD audio codec supports 7.1 channel HD audio and fully complies with Intel® High Definition Audio (Azalia) specifications. To utilize the audio function in Windows platform, you need to install corresponding drivers for Realtek ALC888S-VD codec.

## 2.2.9 10/100/1000/2500 Mbps Ethernet Port

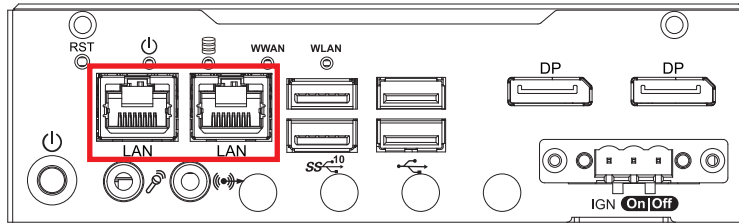

There are two 8-pin RJ-45 jacks supporting 10/100/1000/2500 Mbps Ethernet connections in the front side. LAN at right side is powered by Intel® i225-IT Ethernet engine; LAN at left side is powered by Intel i219-LM Ethernet Phy. When both of LANs work in normal status, iAMT function is enabled. Using suitable RJ-45 cable, you can connect the system to a computer, or to any other devices with Ethernet connection, for example, a hub or a switch. Moreover, both of LANs support Wake on LAN and Pre-boot functions.

## 2.2.10 Remote Power On/Off Switch and Ignition Control

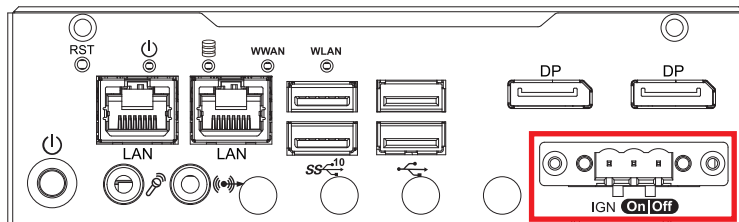

It is a 3-pin power-on/power-off switch through Phoenix Contact terminal block. You could turn on or off the system power by using this contact. This terminal block supports dual function on soft power-on/power-off (instant off or delay four seconds), and suspend mode. Another function is provided ignition power control feature for in-vehicle applications. The built-in MCU monitors the ignition signal and turns on/off the system according to pre-defined on/off delay period.

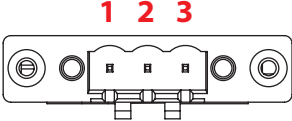
	Pin No.	Definition
	1	Ignition (IGN)
	2	SW+
	3	SW-

## 2.3 Rear Panel I/O & Functions

### 2.3.1 SPC-7000/7100/7200 Rear I/O & Functions

In Vecow's SPC-7000/7100/7200 series family, some of the general connections to the computer device, such as DC-Input power connector, Serial ports and Nano-SIM Card Socket are placed on the rear panel.

### 2.3.2 Power Terminal Block

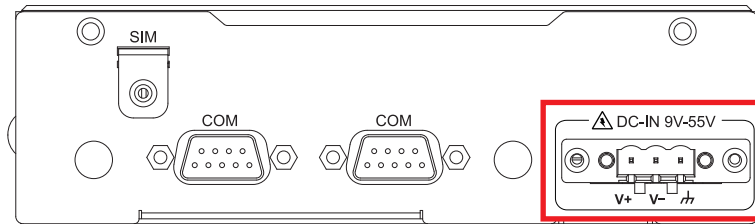

SPC-7000/7100/7200 supports 9V to 55V DC power input.

	Pin No.	Definition
	1	V+
	2	V-
	3	Earth GND

### 2.3.3 Serial Port COM

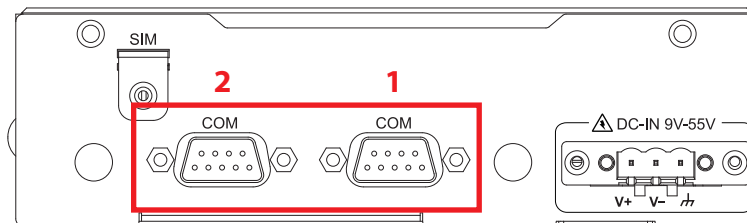

Serial port can be configured for RS-232, RS-422, or RS-485 with auto flow control communication. The default definition is RS-232, but if you want to change to RS-422 or RS-485, you can find the settings in BIOS.

BIOS Setting	Function
COM 1 COM 2	RS-232
	RS-422 (5-wire)
	RS-422 (9-wire)
	RS-485
	RS-485 w/z auto-flow control

### 2.3.4 Nano SIM Card

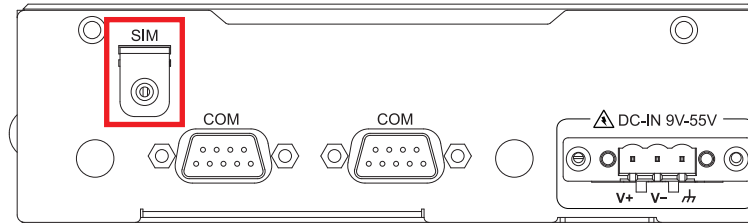

The Nano SIM card socket is support Push-Push type. Please make sure to unplug the system power before inserting the Nano SIM card.

## 2.4 Connector/Jumper Locations

### 2.4.1 SPC-7000/7100/7200 Main Board Top Side View

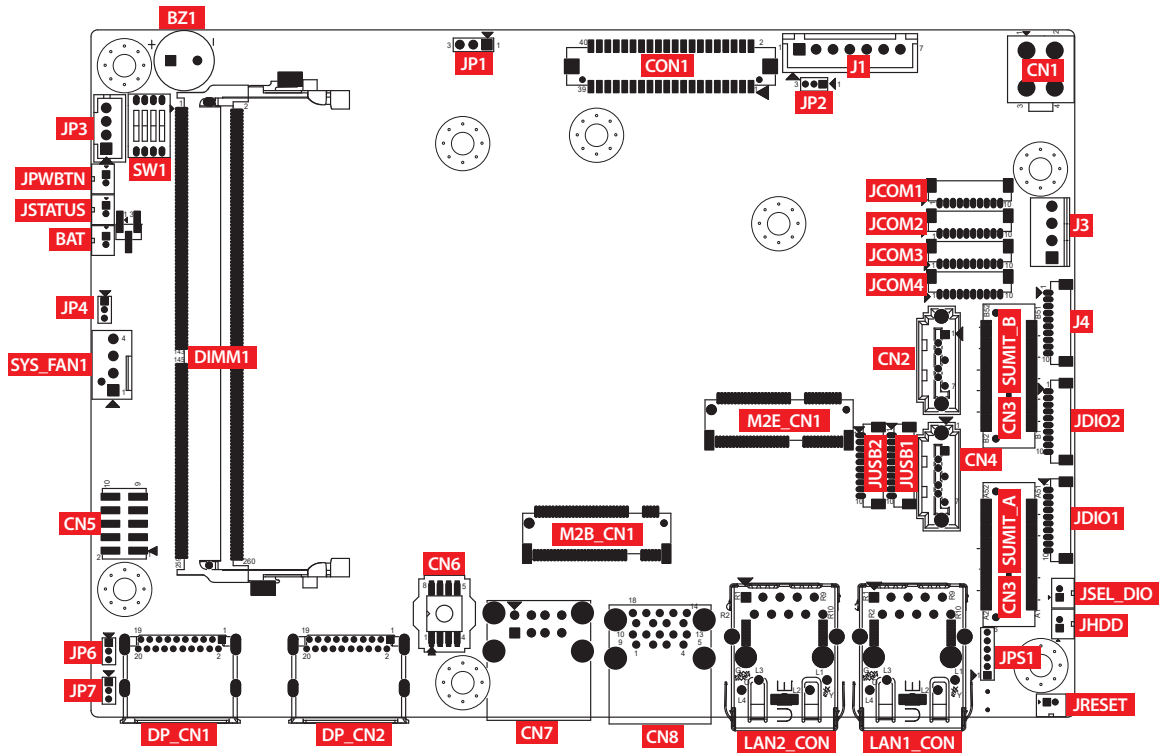

### 2.4.2 SPC-7000/7100/7200 Main Board Bottom Side View

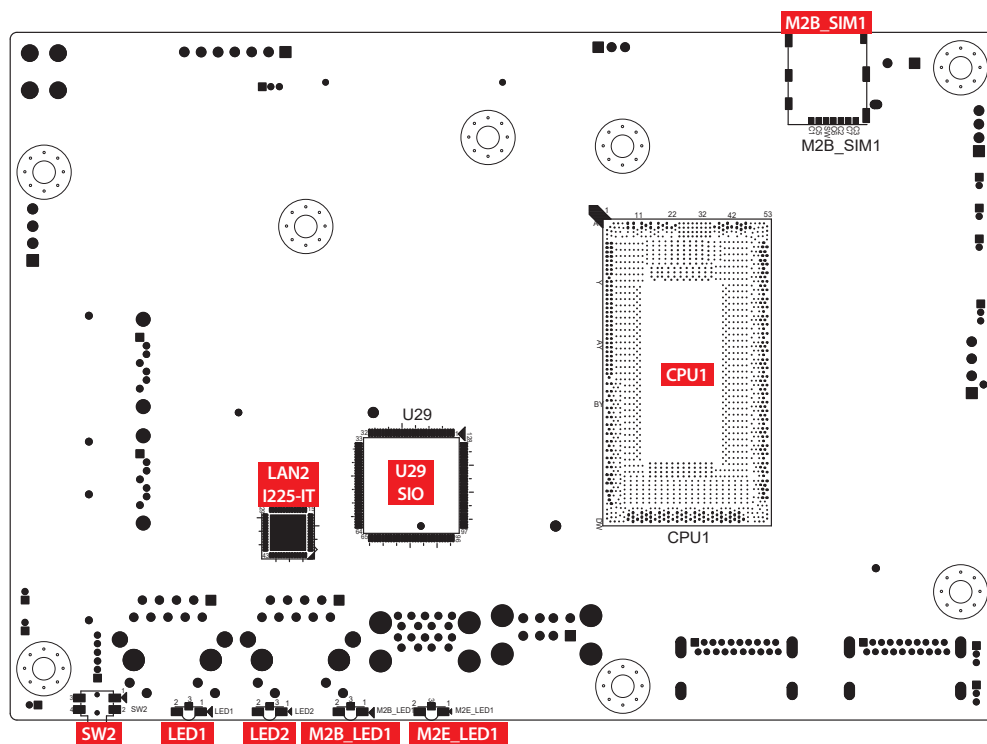

### 2.4.3 JPWBTN, JRESET, JSTATUS, JHDD : Miscellaneous Pin Header

These pin headers can be used as a backup for the following functions : hard drive, LED indicator, reset button, power LED indicator, and power on/off buttons, which already can be accessed by front panel and top panel. The pinouts of Miscellaneous port are listed in following table :

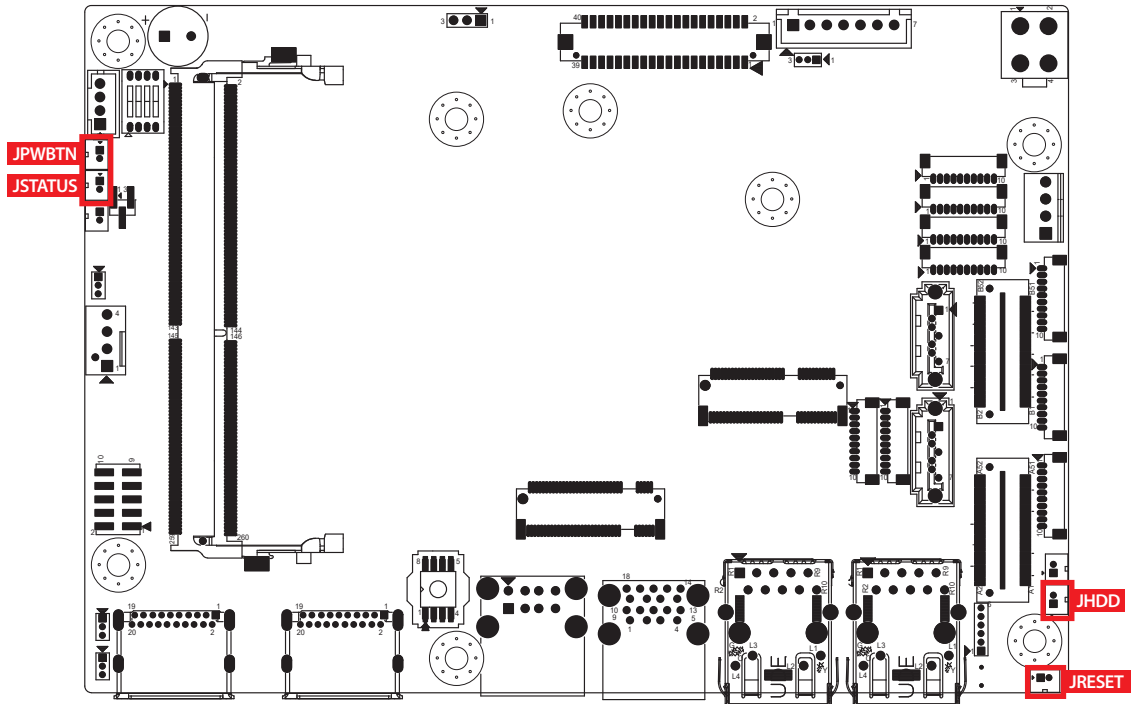

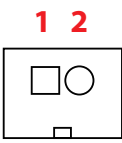
	Group	Pin No.	Description
	JPWBTN	1	GND
		2	FP_PWR_BTN_IN
	JRESET	1	GND
		2	FP_RST_BTN_N
	JSTATUS	1	PWR_LED_N
		2	PWR_LED_P
	JHDD	1	HDD_LED_N
		2	HDD_LED_P

## 2.4.4 BAT : Battery

The EMBC-5000 real-time clock is powered by a lithium battery. It is equipped with Panasonic BR2032 190mAh lithium battery. It is recommended that you not replace the lithium battery on your own, but if the battery needs to be changed, please contact the Vecow RMA service team.

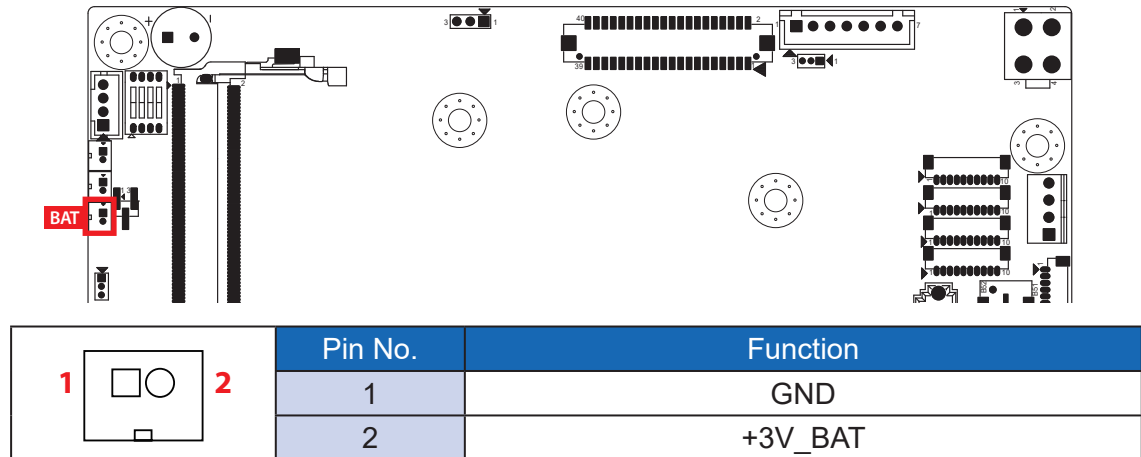

## 2.4.5 CN5 : Audio Connector

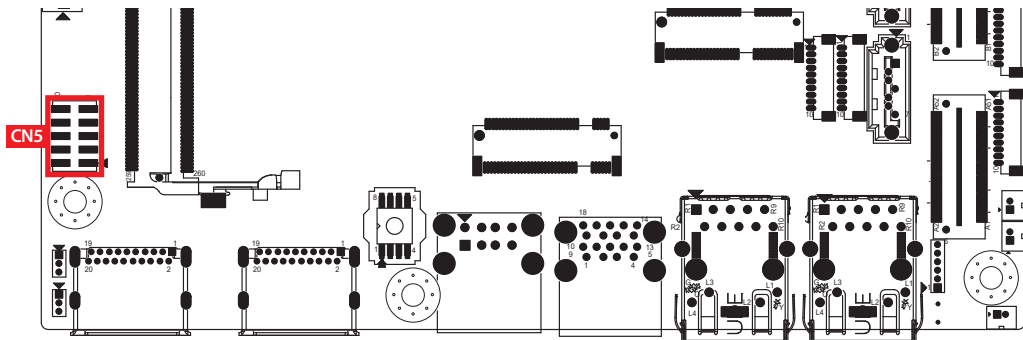

There are three audio connectors, mic-in, line-in, and line-out, in the top side of SPC-7000 series. Onboard Realtek ALC888S-VD audio codec supports 7.1 channel HD audio and fully complies with Intel® High Definition Audio (Azalia) specifications.

To utilize the audio function in Windows platform, you need to install corresponding drivers for both Intel Broadwell-U chipset and Realtek ALC888S-VD codec. Please refer to Chapter 4 for more details of driver installation.

The pinouts of Audio port are listed in the following table :

Pin No.	Definition	Pin No.	Definition
1	A_z_MIC1-L	2	GND_A
3	A_z_MIC1-R	4	GND_EARTH
5	A_z_LINEO-R	6	A_z_LINEI-R
7	F_IO_SENSE	8	GND_EARTH
9	A_z_LINEO-L	10	A_z_LINEI-L



## 2.4.6 JUSB1, JUSB2 : Internal USB 2.0 Connector

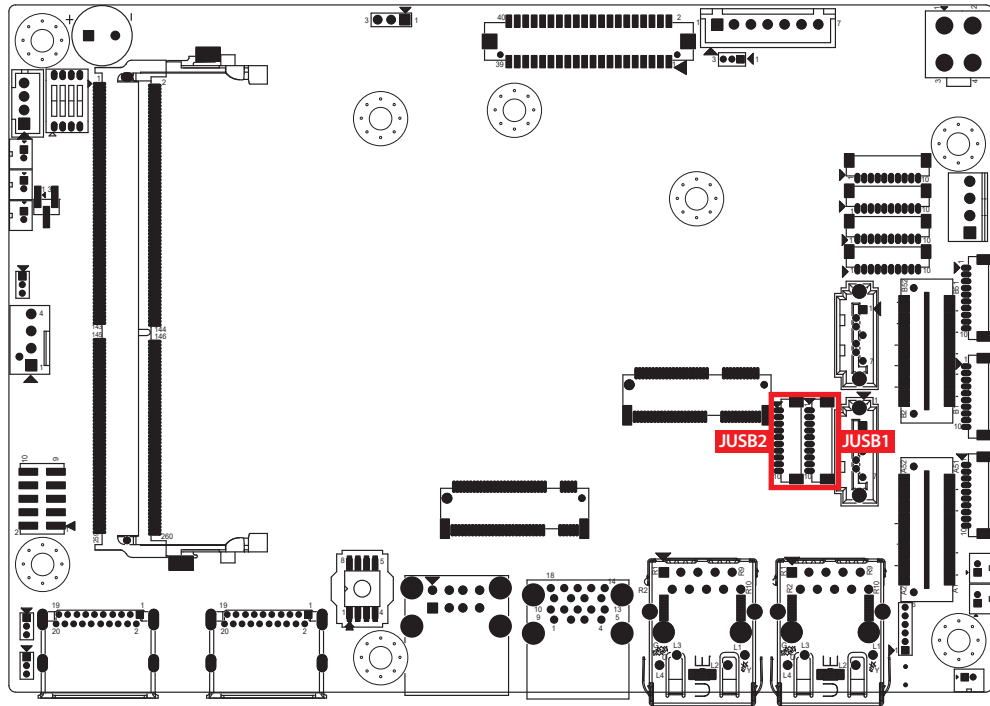

The SPC-7000 series main board provides maxima four expansion USB ports. The USB interface supports 480Mbps transfer rate which comply with high speed USB specification Rev. 2.0.

The USB interface is accessed through one 10-pin JST 1.0mm connector. You will need an adapter cable if you use a standard USB connector. The adapter cable has a 10-pin connector on one end and a USB connector on the other.

The pin assignments of JUSB1 and JUSB2 are listed in the following table :

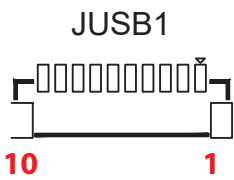
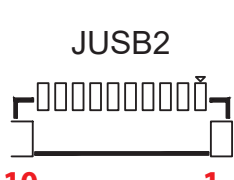
 <p>JUSB1</p>	Pin No.	Definition	Pin No.	Definition
	1	USB_VCC	2	USB_VCC
	3	USB_VCC	4	USB_D_4N
	5	USB_D_4P	6	USB_D_5N
	7	USB_D_5P	8	GND
	9	GND	10	GND
 <p>JUSB2</p>	Pin No.	Definition	Pin No.	Definition
	1	USB_VCC	2	USB_VCC
	3	USB_VCC	4	USB_D_6N
	5	USB_D_6P	6	USB_D_7N
	7	USB_D_7P	8	GND
	9	GND	10	GND

## 2.4.7 M2E\_CN1 : M.2 key E Slot for USB 2.0, PCIe Gen3x1 support

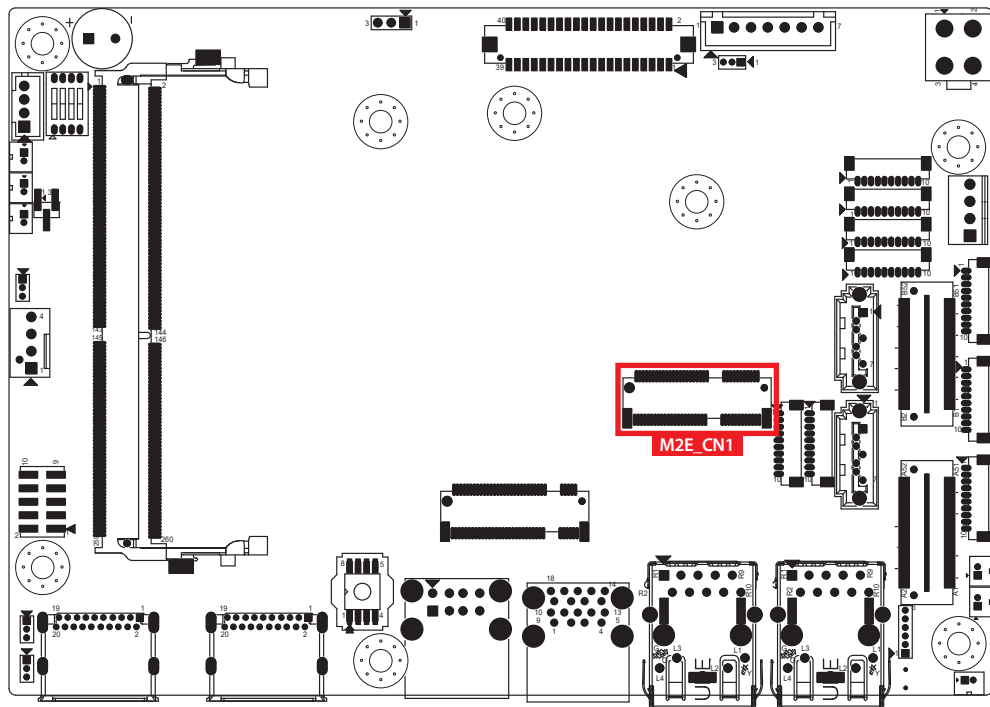

M.2 key E connector is suitable for applications that use wireless connectivity including Wi-Fi, Bluetooth, NFC or GNSS. Module card types include 2230.

The pin assignments of M2E\_CN1 are listed in the following table :

Pin No.	Signal Name	Pin No.	Signal Name
74	3.3V	75	GND
72	3.3V	73	RESERVED/REFCLKn1
70	NC	71	RESERVED/REFCLKp1
68	NC	69	GND
66	NC	67	RESERVED/PETn1
64	NC	65	RESERVED/PETp1
62	ALERT# (O)(0/3.3V)	63	GND
60	12C_CLK (I)(0/3.3V)	61	RESERVED/PERn1
58	12C_DATA (I/O)(0/3.3V)	59	RESERVED/PERp1
56	NC	57	GND
54	NC	55	PEWAKE0# (I/O)(0/3.3V)
52	PERST03# (I)(0/3.3V)	53	CLKREQ0# (I/O)(0/3.3V)

Pin No.	Signal Name	Pin No.	Signal Name
50	NC	51	GND
48	NC	49	REFCLKn0
46	NC	47	REFCLKp0
44	NC	45	GND
42	NC	43	PETn0
40	NC	41	PETp0
38	NC	39	GND
36	NC	37	PERn0
34	NC	35	PERp0
32	NC	33	GND
	Module Key		Module Key
	Module Key		Module Key
	Module Key		Module Key
	Module Key		Module Key
22	NC	23	NC
20	NC	21	NC
18	NC	19	NC
16	NC	17	NC
14	NC	15	NC
12	NC	13	NC
10	NC	11	NC
8	NC	9	NC
6	LED# (O)(od)	7	GND
4	3.3V	5	USB_D-
2	3.3V	3	USB_D+
		1	GND

## 2.4.8 M2B\_CN1 : M.2 key B Slot for PCIe Gen3x2 or USB3.2 Gen2 support (Option by BIOS setting)

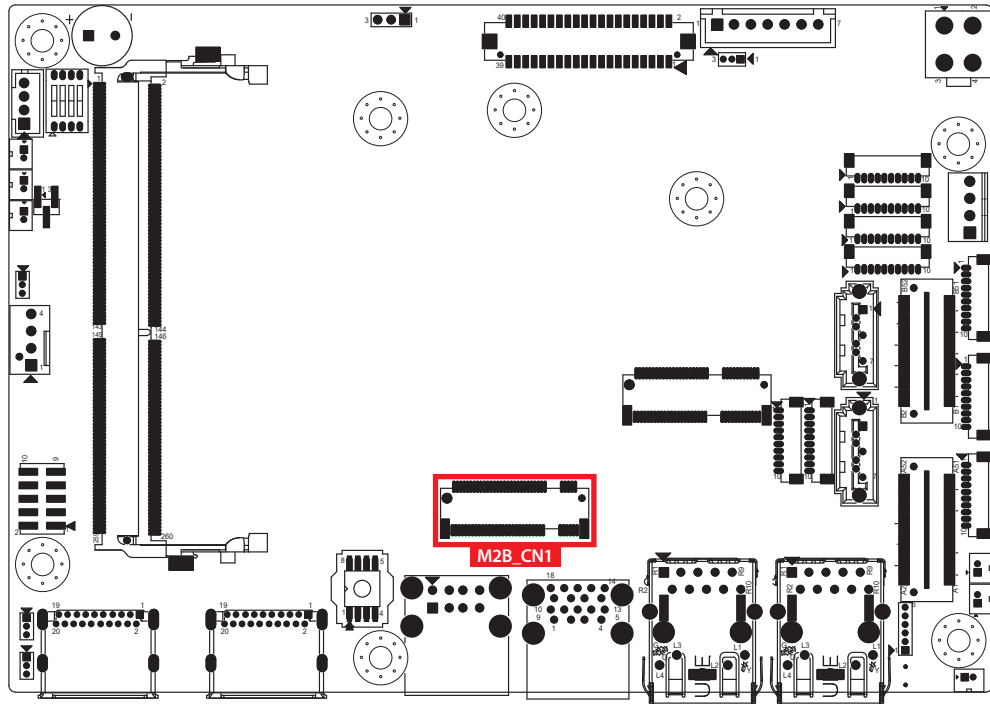

M.2 key B connector is suitable for applications that use wireless connectivity including LTE/5G module, and NVMe SSD (BW : PCIe x2) that types include 2260/3042/3052.

Remind: The default BIOS setting is M.2 Key B for USB3.2 Gen2. If wanting to use NVMe SSD (PCIe Gen3x2), an optional BIOS is required.

The pin assignments of M2B\_CN1 are listed in the following table :

Pin No.	Signal Name	Pin No.	Signal Name
		80	Ground
75	NC		
73	Ground	74	3.3V
71	Ground	72	3.3V
69	CONFIG_1	70	3.3V
67	NC	68	NC
65	NC	66	SIM DETECT
63	NC	64	NC
61	NC	62	NC
59	NC	60	NC

Pin No.	Signal Name	Pin No.	Signal Name
57	Ground	58	NC
55	REFCLKp	56	NC
53	REFCLKn	54	PEWAKE#
51	Ground	52	CLKREQ#
49	PETp0	50	PERST#
47	PETn0	48	NC
45	Ground	46	NC
43	PERp0	44	NC
41	PERn0	42	NC
39	Ground	40	NC
37	PETp1/USB3.1-TX+	38	DEVSLP
35	PETp1/USB3.1-TX-	36	UIM-PWR
33	Ground	34	UIM-DATA
31	PETp1/USB3.1-RX+	32	UIM-CLK
29	PETp1/USB3.1-RX-	30	UIM-RESET
27	Ground	28	NC
25	NC	26	NC
23	NC	24	NC
21	NC	22	NC
		20	NC
Mechanical Key			
11	Ground		
9	USB-	10	LED_1#
7	USB+	8	W_DISABLE1
5	Ground	6	FULL_CARD_PWR_OFF/ON
3	Ground	4	3.3V
1	NC	2	3.3V

## 2.4.9 JCOM1, JCOM2, JCOM3, JCOM4 : Serial Port

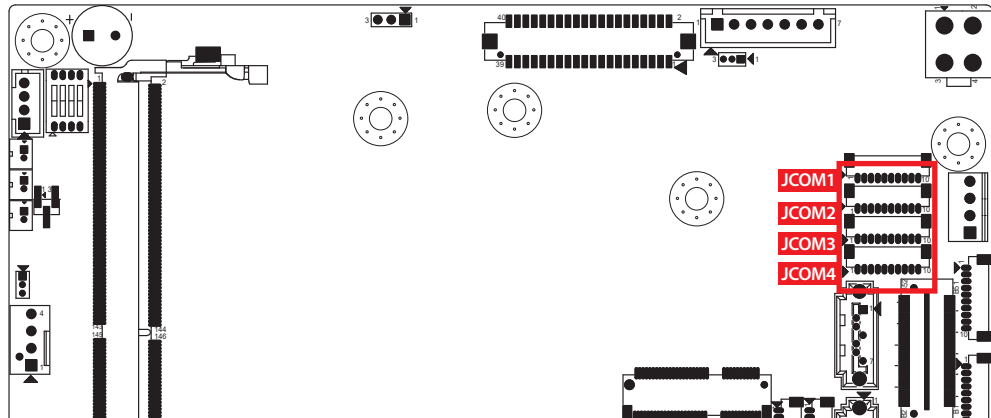

Serial port 1 to 4 (JCOM 1 to 4) can be configured for RS-232, RS-422, or RS-485 with auto flow control communication. The default definition of COM 1 to 4 is RS-232, if you want to change to RS-422 or RS-485, you can find the setting in BIOS.

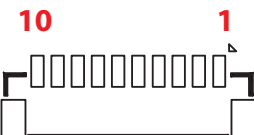
	BIOS Setting	Function	
	COM 1 (JCOM1) COM 2 (JCOM2) COM 3 (JCOM3) COM 4 (JCOM4)		RS-232
			RS-422 (5-wire)
			RS-422 (9-wire)
			RS-485
		RS-485 w/z auto-flow control	

The pin assignments are listed in the following table :

Serial Port	Pin No.	RS-232	RS-422 (5-wire)	RS-485 (3-wire)
1, 2 3, 4	1	GND_EARTH	GND_EARTH	GND_EARTH
	2	GND	GND	GND
	3	RI	-----	RI
	4	DTR	RXD-	-----
	5	CTS	-----	-----
	6	TXD	RXD+	-----
	7	RTS	-----	-----
	8	RXD	TXD+	DATA+
	9	DSR	-----	-----
	10	DCD	TXD-	DATA-

### 2.4.10 CN7 : External USB 2.0 Connector

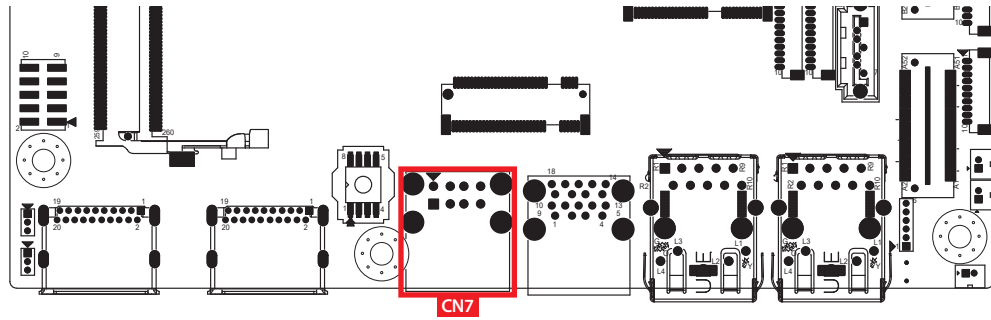

There are 2 USB 2.0 ports available supporting up to 480MB per second data rate in the front side of SPC-7000 series. They are also compliant with the requirements of high speed (HS), full speed (FS) and low speed (LS).

### 2.4.11 CN8 : External USB 3.2 Connector

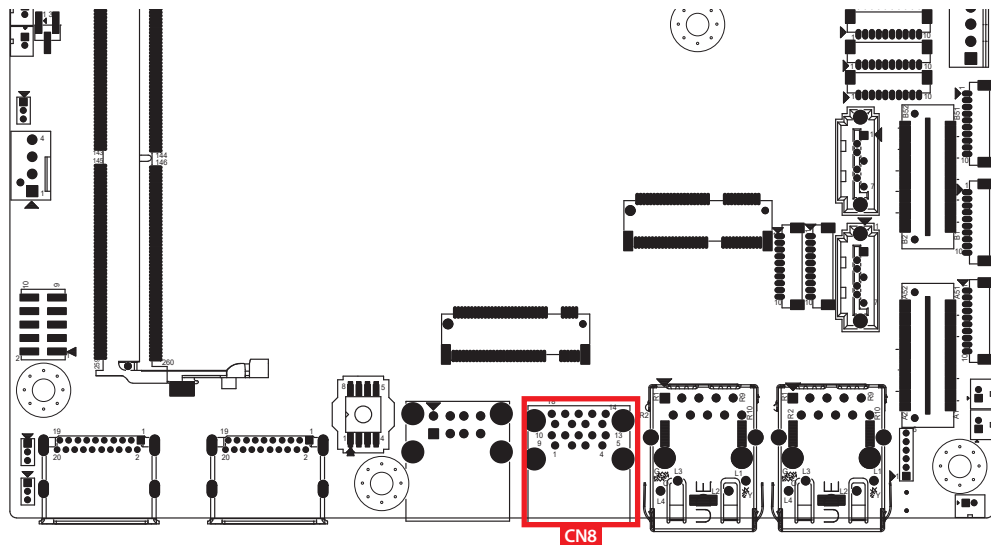

There are 2 USB 3.2 Gen2 connections available supporting up to 10GB per second data rate in the top side of SPC-7000 series. They are also compliant with the requirements of SuperSpeed (SS), high speed (HS), full speed (FS) and low speed (LS).

## 2.4.12 LAN1\_CON , LAN2\_CON : LAN Connector

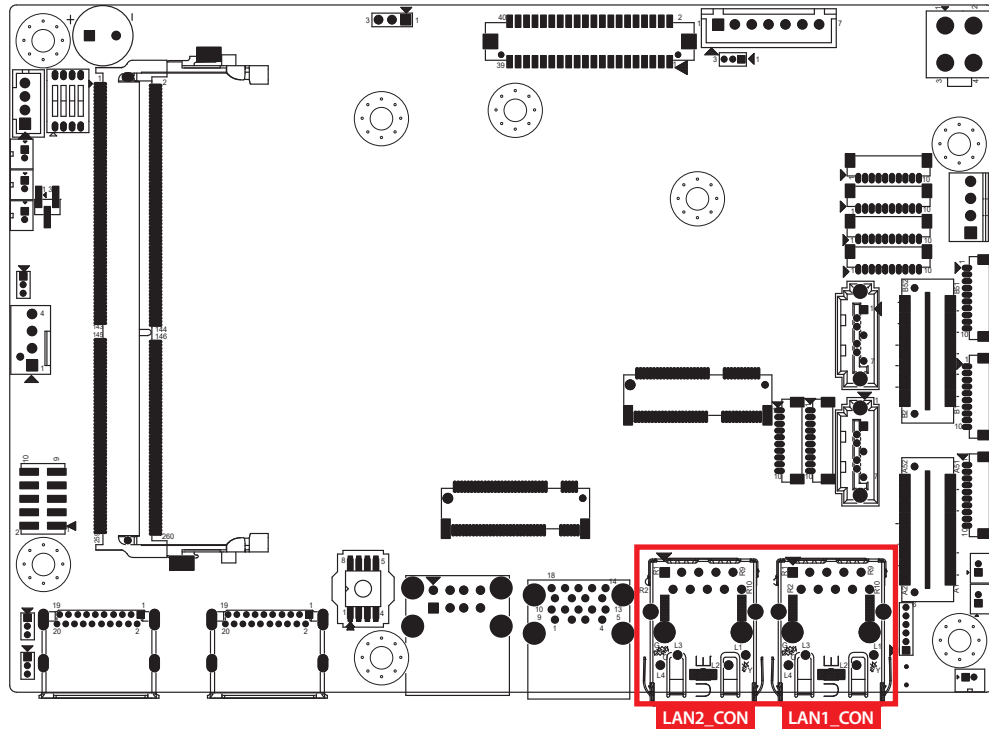

There are two 8-pin RJ-45 jacks supporting 10/100/1000/2500 Mbps Ethernet connections in the front side of SPC-7000 series. LAN1\_CON is powered by Intel® I219-LM Ethernet engine; LAN2\_CON is powered by Intel® I225-IT Ethernet engine.

Using suitable RJ-45 cable, you can connect SPC-7000 series system to a computer or to any other devices with Ethernet connection, for example, a hub or a switch. Moreover, both LAN1 and LAN2 support Wake on LAN and Pre-boot functions. The pinouts of LAN1\_CON and LAN2\_CON are listed as follow :

Pin No.	10/100Mbps	1000Mbps	2500Mbps
1	E_TX+	MDI0_P	MDI0_P
2	E_TX-	MDI0_N	MDI0_N
3	E_RX+	MDI1_P	MDI1_P
4	-----	MDI2_P	MDI2_P
5	-----	MDI2_N	MDI2_N
6	E_RX-	MDI1_N	MDI1_N
7	-----	MDI3_P	MDI3_P
8	-----	MDI3_N	MDI3_N



Each LAN port is supported by standard RJ-45 connector with LED indicators to present Active/Link/Speed status of the connection.

LED Location	LED Color	10Mbps	100Mbps	1000Mbps
Right	Green/Orange	Off	Solid Orange	Solid Green
Left	Yellow	Twinkling Yellow	Twinkling Yellow	Twinkling Yellow

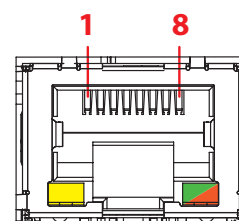

The LED indicator on the right top corner of LAN1\_CON lightens in solid green when the cable is properly connected to a 1000Mbps Ethernet network; the LED indicator on the right top corner of LAN1\_CON lightens in solid orange when the cable is properly connected to a 100Mbps Ethernet network; the LED indicator on the Left top corner of LAN1\_CON will keep twinkling/off when Ethernet data packets are being transmitted/received.

LED Location	LED Color	10Mbps	100Mbps	1000Mbps
Right	Green/Orange	Off	Solid Orange	Solid Green
Left	Yellow	Twinkling Yellow	Twinkling Yellow	Twinkling Yellow

The LED indicator on the right top corner of LAN2\_CON lightens in solid green when the cable is properly connected to a 2500Mbps Ethernet network; the LED indicator on the right top corner of LAN2\_CON lightens in solid orange when the cable is properly connected to a 1000Mbps Ethernet network; the LED indicator on the Left top corner of LAN2\_CON will keep twinkling/off when Ethernet data packets are being transmitted/received.

LED Location	LED Color	10/100 Mbps	1000Mbps	2500Mbps
Right	Green/Orange	Off	Solid Orange	Solid Green
Left	Yellow	Twinkling Yellow	Twinkling Yellow	Twinkling Yellow

### 2.4.13 CON1, J3 : LVDS

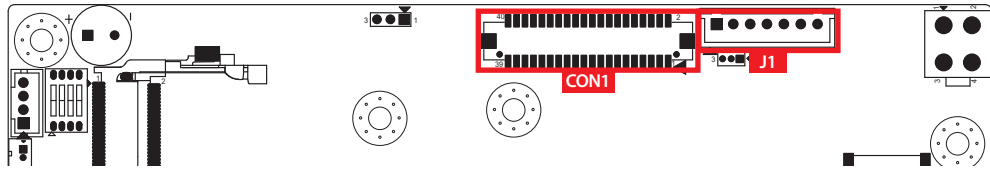

SPC-7000 series supports dual-channel 24-bit LVDS display and up to 4096 x 2304 pixels resolution.

The pin assignments of LVDS are listed in the following table :

Pin No.	Definition	Pin No.	Definition
1	PANEL_VDD	2	TXO0-
3	PANEL_VDD	4	TXO0+
5	PANEL_VDD	6	TXO1-
7	GND	8	TXO1+
9	GND	10	TXO2-
11	GND	12	TXO2+
13	GND	14	TXOC-
15	GND	16	TXOC+
17	GND	18	TXO3-
19	GND	20	TXO3+
21	GND	22	TXE0-
23	GND	24	TXE0+
25	GND	26	TXE1-
27	GND	28	TXE1+
29	GND	30	TXE2-
31	GND	32	TXE2+
33	GND	34	TXEC-
35	GND	36	TXEC+
37	GND	38	TXE3-
39	LVDS_DET#	40	TXE3+

The LCD inverter is connected to J1 via a JST 7-pin, 2.5mm connector providing +5V/ +12V power to LCD display. The pin assignments are listed in the following table :

Pin No.	Definition	Pin No.	Definition
1	+5V	2	+12V
3	+12V	4	LBKLT_CTL
5	GND	6	GND
7	LBKLT_EN		

## 2.4.14 DP\_CN1, DP\_CN2 : DP Connectors

SPC-7000 series support 2 Display Ports and up to 4096 x 2304 pixels resolution.

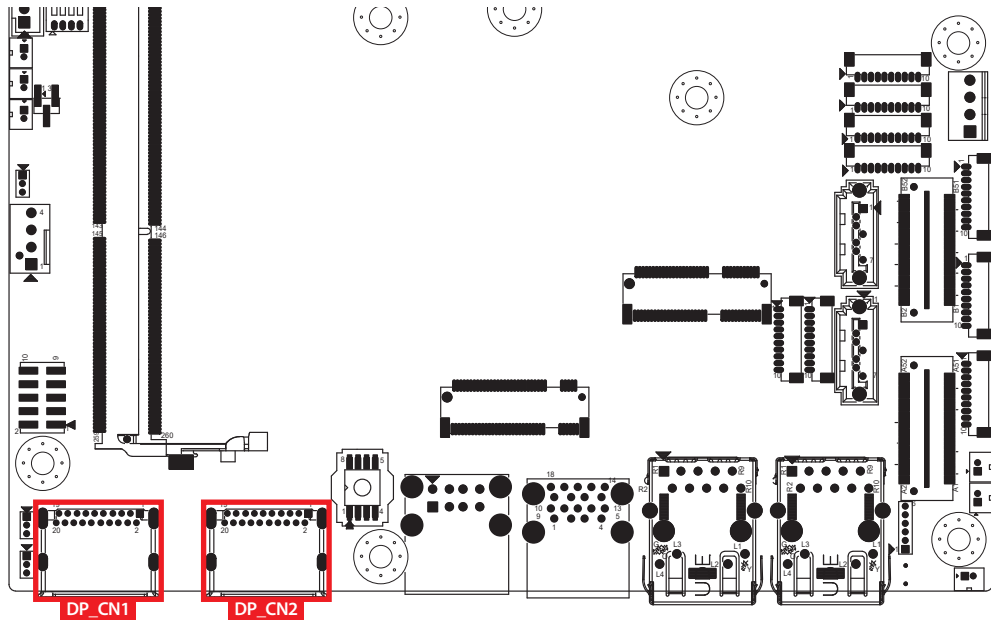

## 2.4.15 CN1 : DC Power input

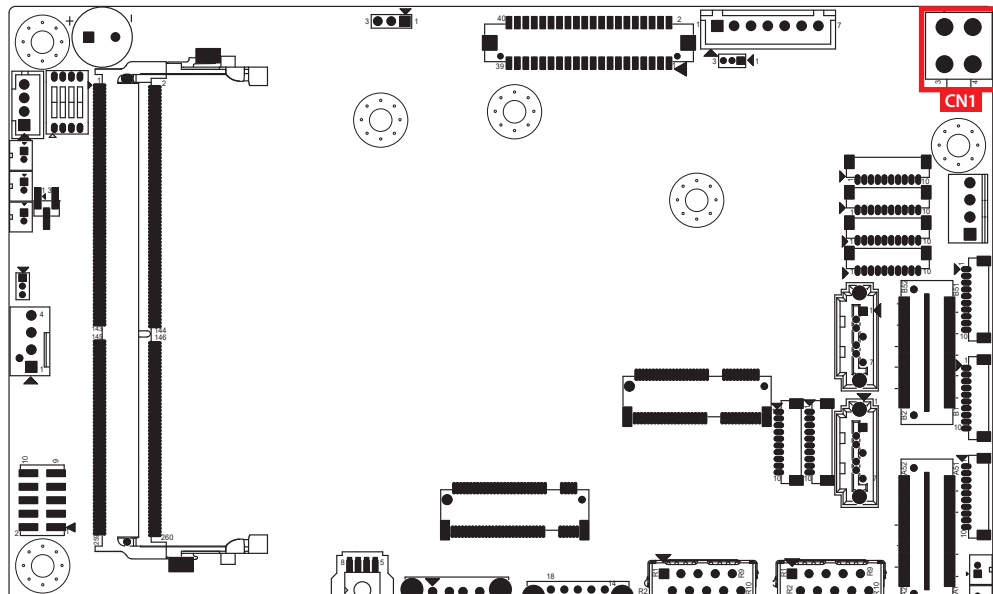

SPC-7000 series supports 9V to 55V DC power input by wire-to-board connector in the top side.

	Pin No.	Definition	Pin No.	Definition
	1	V-	2	V-
	3	V+	4	V+

## 2.4.16 CN2, CN4 : SATA III Connector

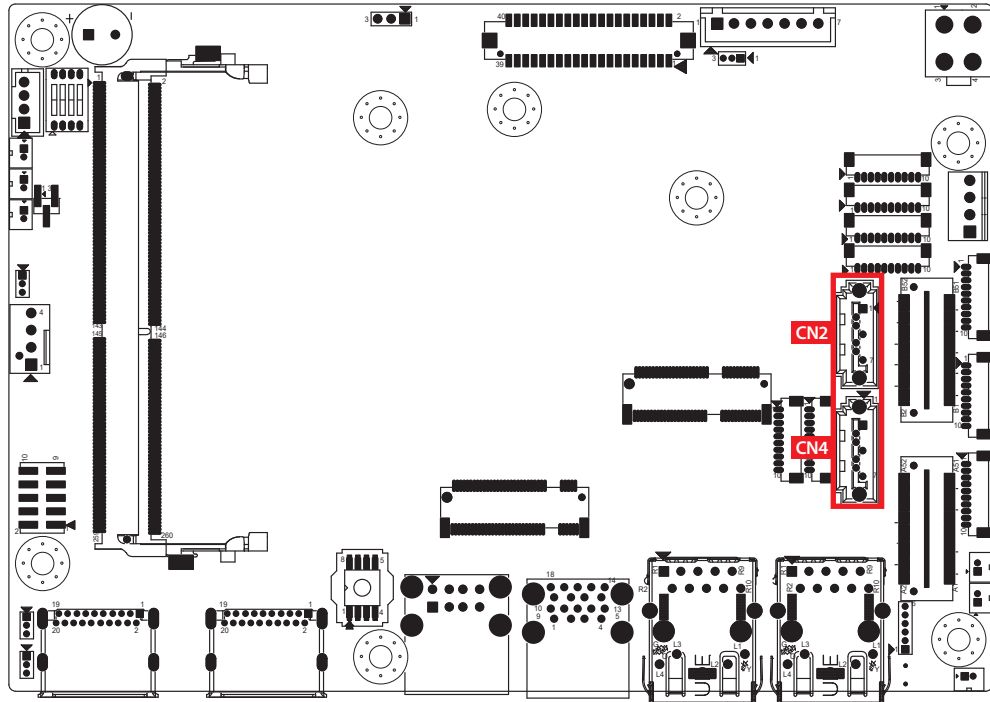

There are two high performance Serial ATA III (SATA III) on the SPC-7000 series. They support higher storage capacity with less cabling effort and smaller required space. The pin assignments of CN2 and CN4 are listed in the following table :

	Pin No.	Definition	Pin No.	Definition
	1	GND	2	TXP
	3	TXN	4	GND
	5	RXN	6	RXP
	7	GND		

## 2.4.17 J3 : SATA Power Connector

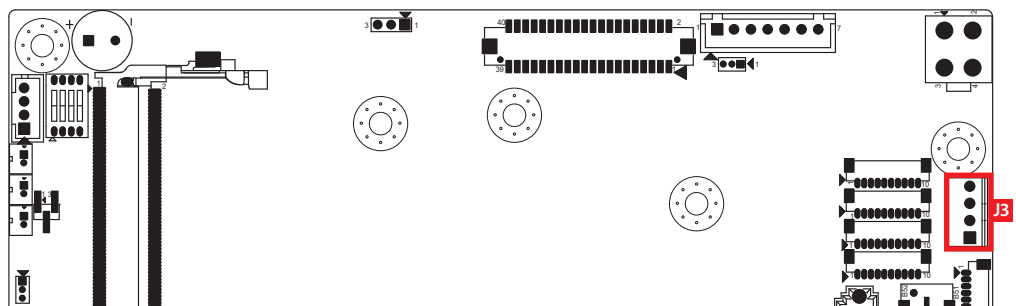

The SPC-7000 series is also equipped with one SATA power connector. It supports 5V (Up to 2A) and 12V (Up to 2A) currents to the hard drive or SSD. The pin assignments of J3 is listed in the following table :

	Pin No.	Definition	Pin No.	Definition
	1	+12V	2	GND
	3	GND	4	+5V

## 2.4.18 CN3 : SUMIT A+B Connector

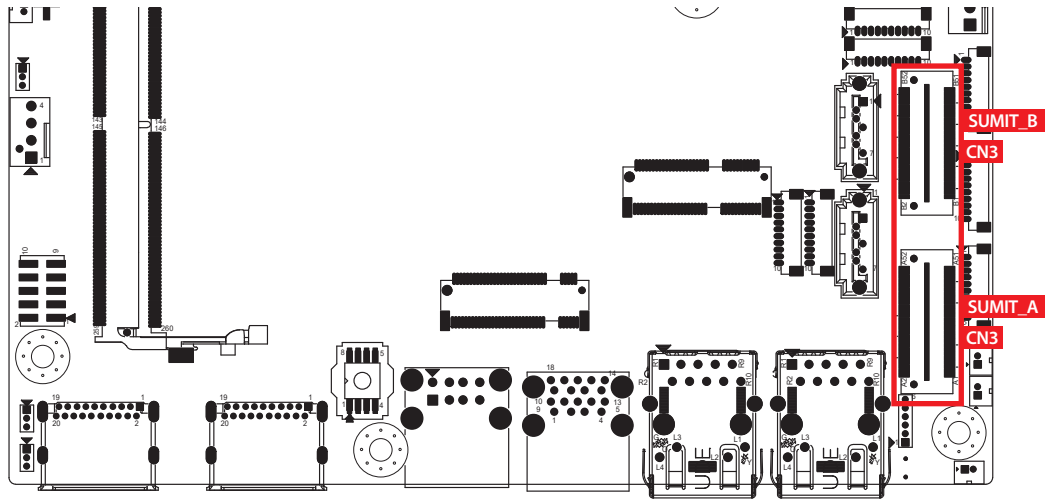

SUMIT-A Connector Pin Out :

Pin No.	Definition	Pin No.	Definition
1	+5V_AUX	2	+12V
3	+3.3V	4	SMB_DATA
5	+3.3V	6	SMB_CLK
7	Reserved	8	Reserved
9	Reserved	10	Reserved
11	USB_OC#	12	Reserved
13	Reserved	14	Reserved
15	+5V	16	Reserved
17	USB_3+	18	Reserved
19	USB_3-	20	Reserved
21	+5V	22	Reserved
23	USB_2+	24	LPC_AD0
25	USB_2-	26	LPC_AD1
27	+5V	28	LPC_AD2
29	USB_1+	30	LPC_AD3
31	USB_1-	32	LPC_FRAME#
33	+5V	34	SERIRQ#
35	USB_0+	36	Reserved
37	USB_0-	38	CLK_33MHz
39	GND	40	GND
41	A_PET_P0	42	A_PER_P0
43	A_PET_N0	44	A_PER_N0
45	GND	46	GND
47	PERST#	48	A_CLKP
49	WAKE#	50	A_CLKN
51	+5V	52	GND

SUMIT-B Connector Pin Out :

Pin No.	Definition	Pin No.	Definition
1	GND	2	GND
3	B_PET_P0	4	B_PER_P0
5	B_PET_N0	6	B_PER_N0
7	GND	8	GND
9	C_CLKP	10	B_CLKP
11	C_CLKN	12	B_CLKN
13	CPRSNT#/C_PE_CLKREQ#	14	GND
15	C_PET_P0	16	C_PER_P0
17	C_PET_N0	18	C_PER_N0
19	GND	20	GND
21	C_PET_P1	22	C_PER_P1
23	C_PET_N1	24	C_PER_N1
25	GND	26	GND
27	C_PET_P2	28	C_PER_P2
29	C_PET_N2	30	C_PER_N2
31	GND	32	GND
33	C_PET_P3	34	C_PER_P3
35	C_PET_N3	36	C_PER_N3
37	GND	38	GND
39	PERST#	40	WAKE#
41	Reserves	42	Reserves
43	+5V	44	Reserves
45	+5V	46	+3.3V
47	+5V	48	+3.3V
49	+5V	50	+3.3V
51	+5V	52	+5V_AUX

## 2.4.19 SYS\_FAN1

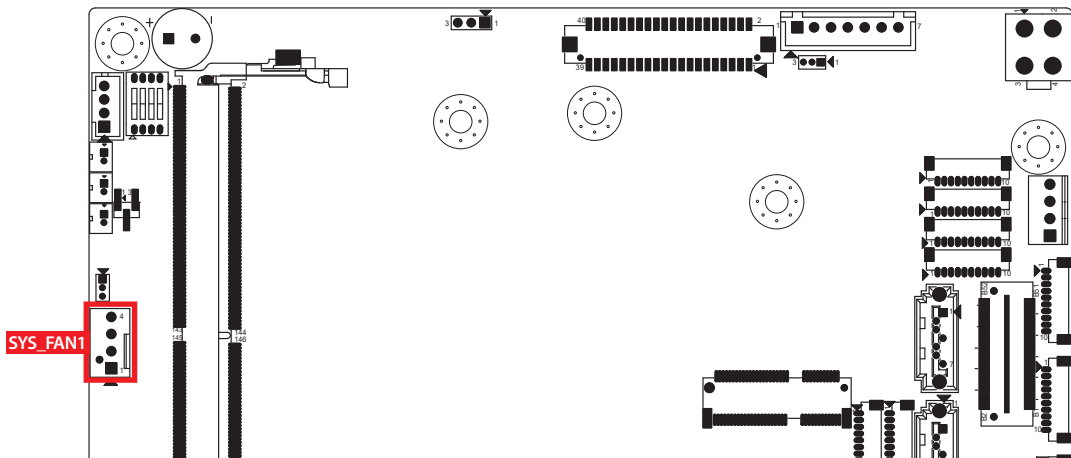

Fan power connector supports higher thermal requirements

	Pin No.	Definition	Pin No.	Definition
	1	1	GND	2
4	3	Fan speed sensor	4	Fan PWM

## 2.4.20 JPS1 : PS/2 Keyboard and Mouse

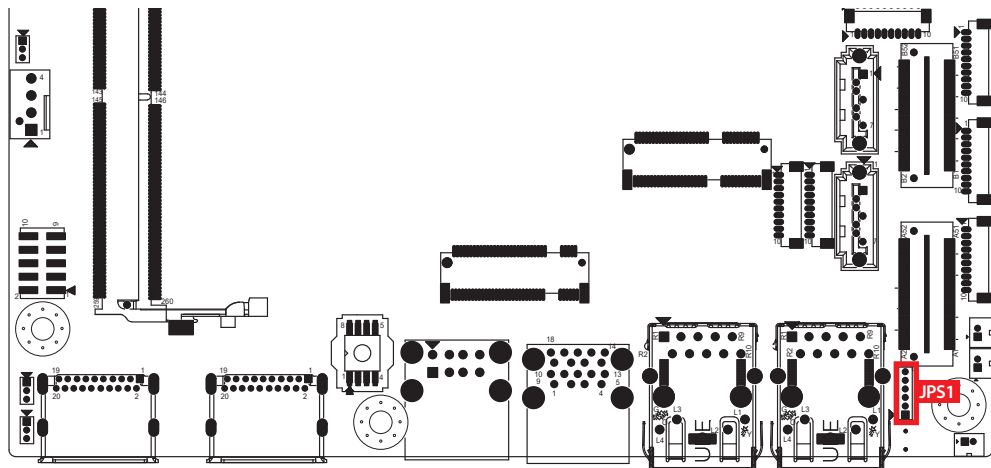

JPS1 Keyboard and mouse pin assignment as the following table :

	Pin No.	Definition	Pin No.	Definition
	1	1	SIO_MCLK	2
6	3	GND	4	SIO_KCLK
	5	SIO_KDAT	6	VCC5_KBMS

## 2.4.21 JDIO1, JDIO2 : GPIO from Super I/O

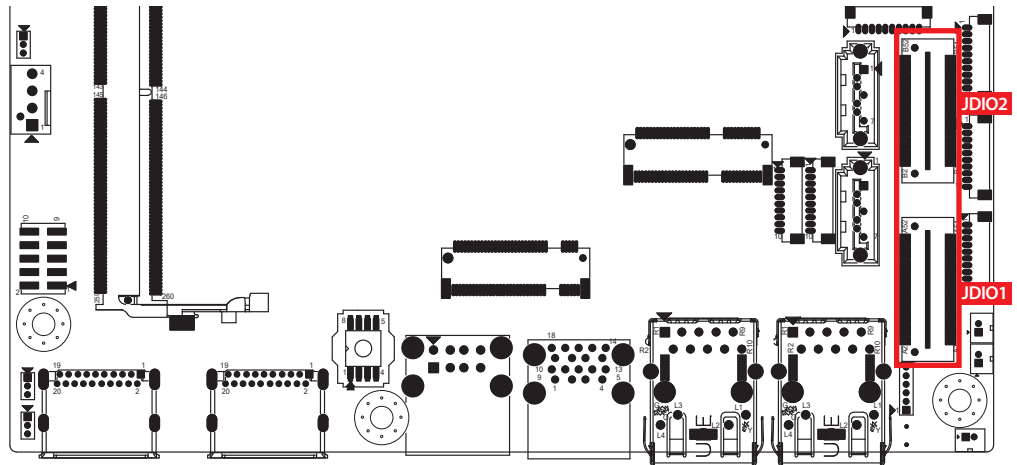

There is a 16-bit GPIO connector in the Top side. Each GPIO channel can be configuration GPI or GPO.

JSEL\_DIO header is for SYNC/SOURCE mode selection on ISO\_DIO board (DMX-100-E)

JDIO1 and JDIO2 pins are defined in the following table :

	Pin No.	JDIO1 Definition	JDIO2 Definition
	1	SIO_GPI80	SIO_GPO70
	2	SIO_GPI81	SIO_GPO71
	3	SIO_GPI82	SIO_GPO72
	4	SIO_GPI83	SIO_GPO73
	5	SIO_GPI84	SIO_GPO74
	6	SIO_GPI85	SIO_GPO75
	7	SIO_GPI86	SIO_GPO76
	8	SIO_GPI87	SIO_GPO77
	9	+3.3V	+3.3V
10	GND	GND	

## 2.4.22 SW2 : RESET Button

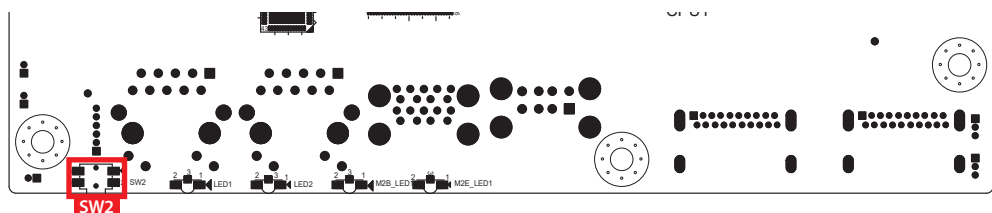

Pin assignment as the following table :

	Pin No.	Definition	Pin No.	Definition
	1	FP_RST_BTN_N	2	GND
	3	FP_RST_BTN_N	4	GND



### 2.4.23 JP3 : IGNITION Control and Remote Power on switch

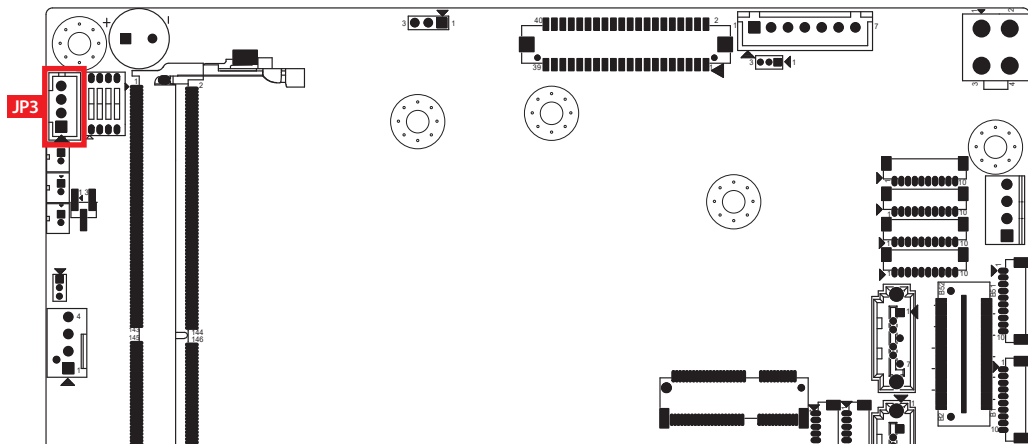

Pin assignment as the following table :

	Pin No.	Definition	Pin No.	Definition
	1	FP_PWR_BTN_P	2	GND
3	IGNITION	4	GND	

### 2.4.24 M2B\_SIM1 : Nano SIM Card Socket for M.2 key B Slot

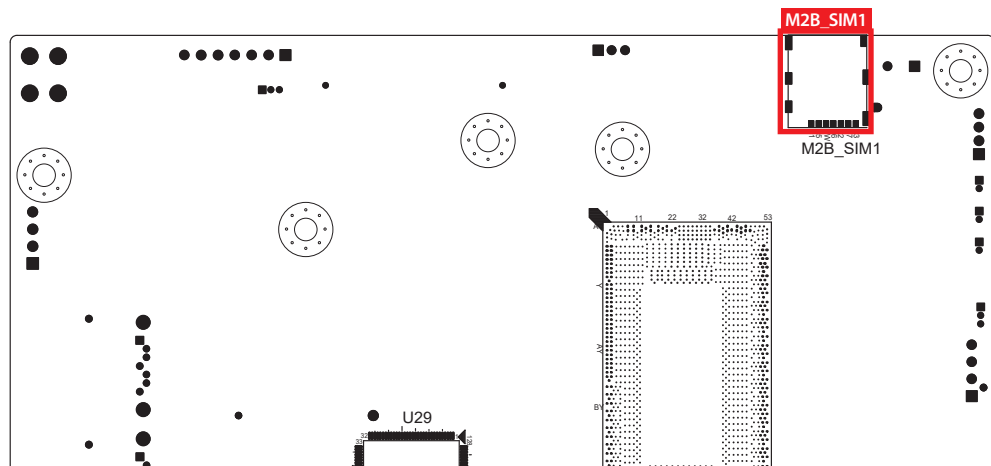

The Nano SIM card socket is support Push-Push type. Please make sure to unplug the system power before inserting the Nano SIM card.

## 2.5 Main Board Jumper Settings

### 2.5.1 Front View of SPC-7000/7100/7200 Main Board With Jumper Location

The figure below is the top view of the EMBC-5000 main board. It shows the location of the jumpers.

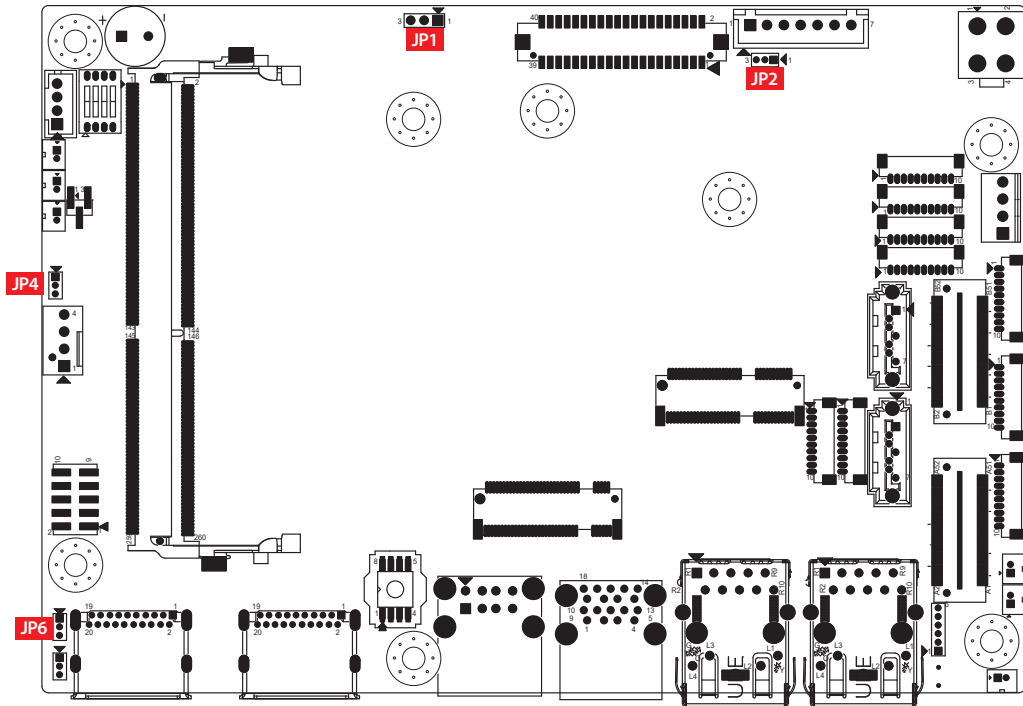

You may configure your card to match the needs of your application by setting jumpers. A jumper is a metal bridge used to close an electric circuit. It consists of two metal pins and a small metal clip (often protected by a plastic cover) that slides over the pins to connect them. To "close" a jumper, you connect the pins with the clip. To "open" a jumper, you remove the clip. Sometimes a jumper will have three pins, labeled 1, 2, and 3. In this case you would connect either pins 1 and 2, or 2 and 3.

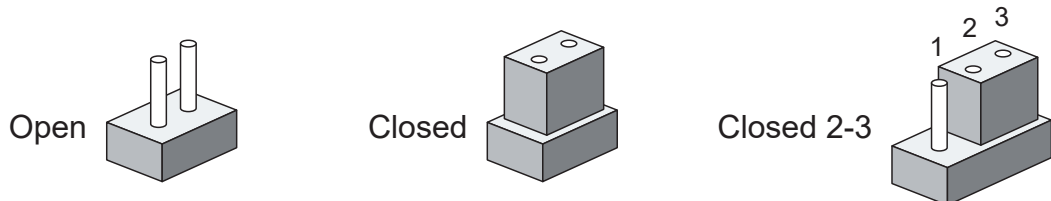

## 2.5.2 JP1 : Power Selection for LVDS Module

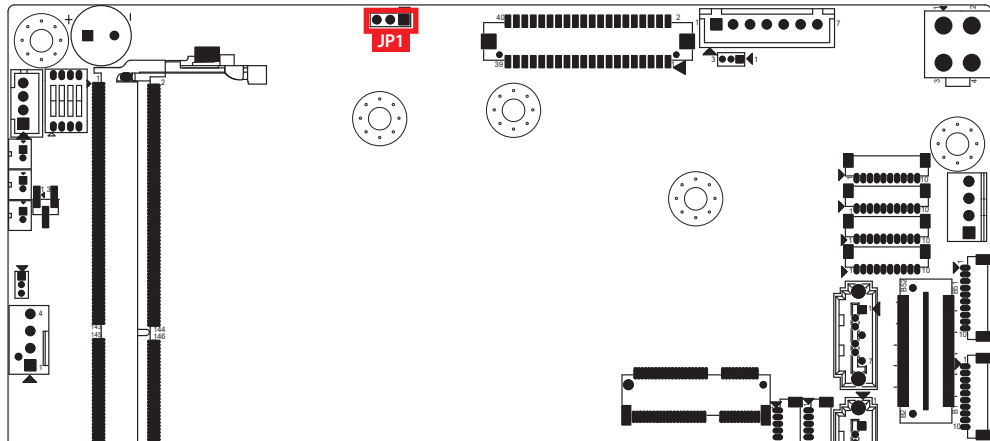

JP1 provides LVDS voltage selection function, Closing Pin 1 and Pin 2 is for 3.3V LVDS power input; closing Pin 2 and Pin 3 is for 5V LVDS power input.

	Pin No.	Definition
		1-2
	2-3	+5V

## 2.5.3 JP2 : Backlight Control Level Selection

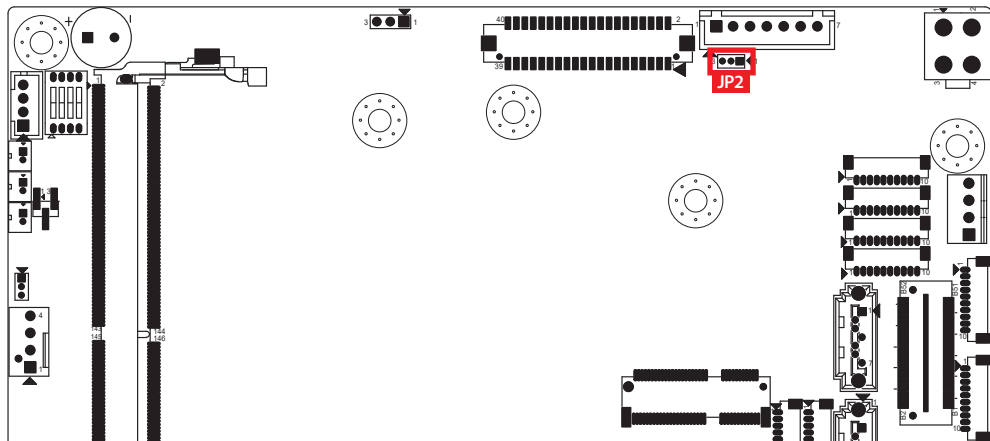

	Pin No.	Definition
		1-2
	2-3	+5V

### 2.5.4 JP4 : Clear CMOS

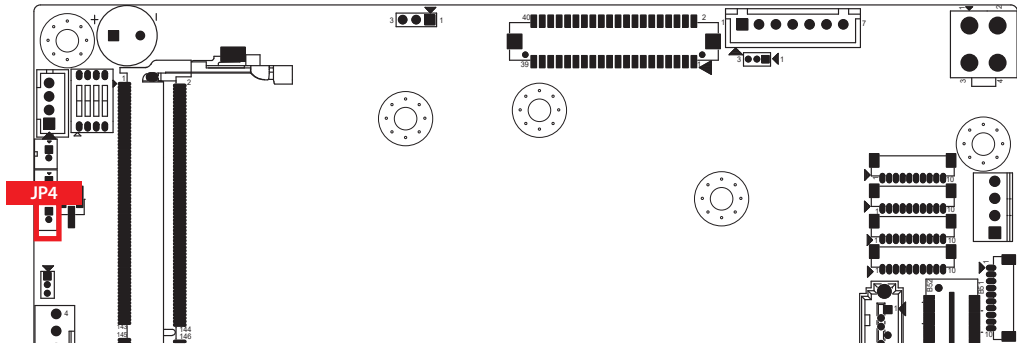

	Pin No.	Definition
	1-2	Normal
	2-3	Clear CMOS

### 2.5.5 JP6 : Power Selection for EXT and INT USB 3.2 Gen2/USB 2.0 Ports

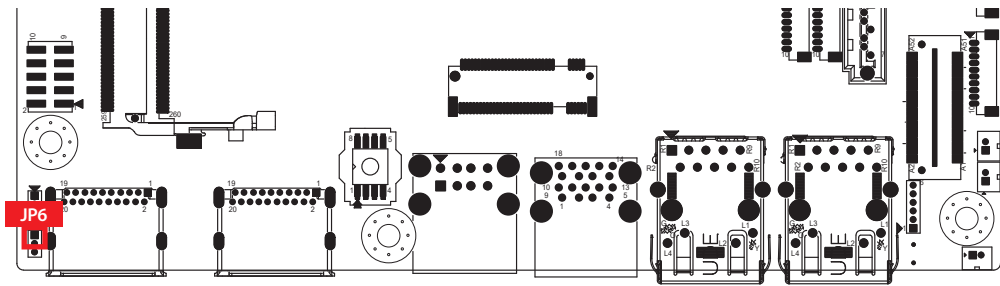

	Pin No.	Definition
	1-2	+5V Standby Power
	2-3	+5V System Power

### 2.5.6 JIGNMODE1 : IGNITION Mode

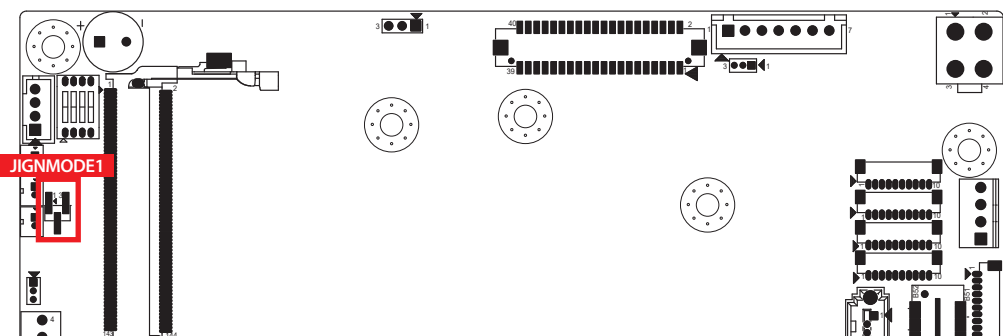

	Pin No.	Definition
	1-2	H/W mode
	2-3	S/W mode (Default)

## 2.6 Ignition Control





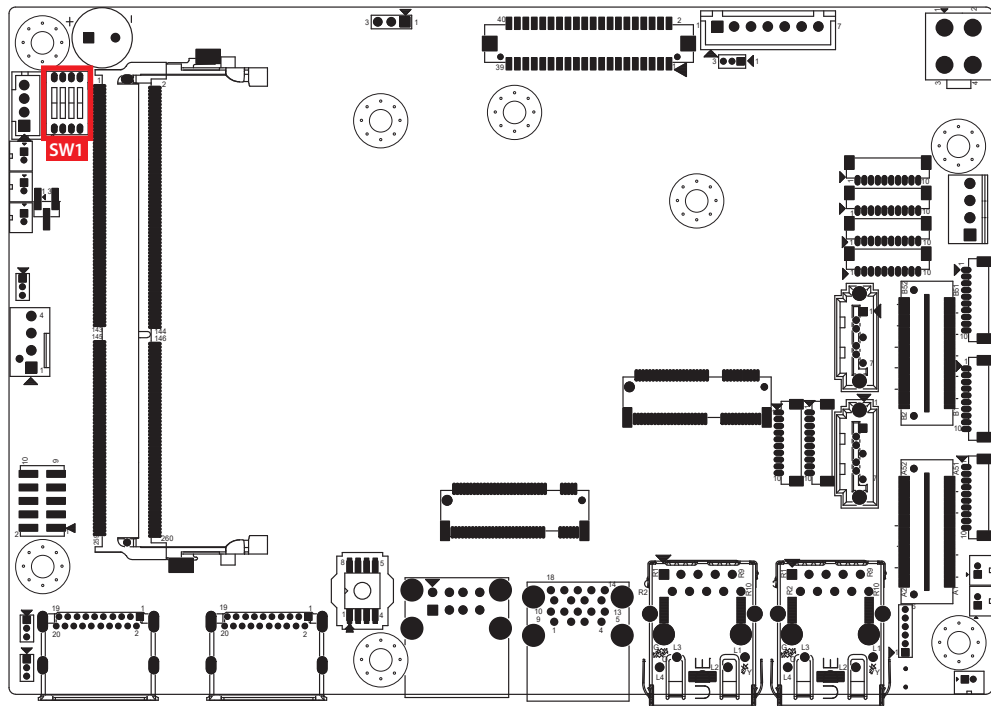

SPC-7000 series series provides ignition power control feature for in-vehicle applications. The built-in MCU monitors the ignition signal and turns on/off the system according to pre-defined on/off delay period.

### 2.6.1 Adjust Ignition Control Modes

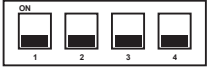
SPC-7000 series series provides 16 modes of different power on/off delay periods adjustable via SW1 switch. The default rotary switch is set to 0 in ATX/AT power mode.

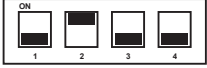
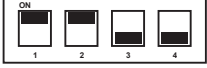
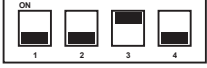
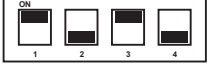
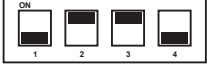
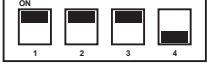
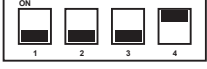
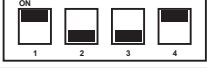
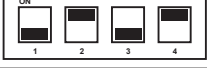

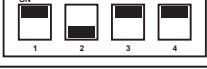
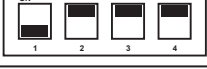
The modes are listed in the following table :

DIP Switch Position	Power on delay	Power off delay	Switch Position
0	ATX/AT mode (Default)		
1	No delay	No delay	
2	No delay	5 seconds	
3	No delay	10 seconds	
4	No delay	20 seconds	
5	5 seconds	30 seconds	
6	5 seconds	60 seconds	
7	5 seconds	90 seconds	
8	5 seconds	30 minutes	
9	5 seconds	1 hour	
A	10 seconds	2 hours	
B	10 seconds	4 hours	
C	10 seconds	6 hours	
D	10 seconds	8 hours	
E	10 seconds	12 hours	
F	10 seconds	24 hours	

## 2.6.2 Ignition Control Wiring

To activate ignition control, you need to provide IGN signal via the 3-pin pluggable terminal block locates in the back panel. Please find below the general wiring configuration

Pin No.	Definition
1	Ignition (IGN)
2	SW+
3	SW-



For testing purpose, you can refer to the picture blow to simulate ignition signal input controlled by a latching switch.

Note :

1. DC power source and IGN share the same ground.
2. SPC-7000 series supports 9V to 55V wide range DC power input in ATX/AT mode. In Ignition mode, the input voltage is fixed to 12V/24V for car battery scenario.
3. For proper ignition control, the power button setting should be "Power Down" mode.

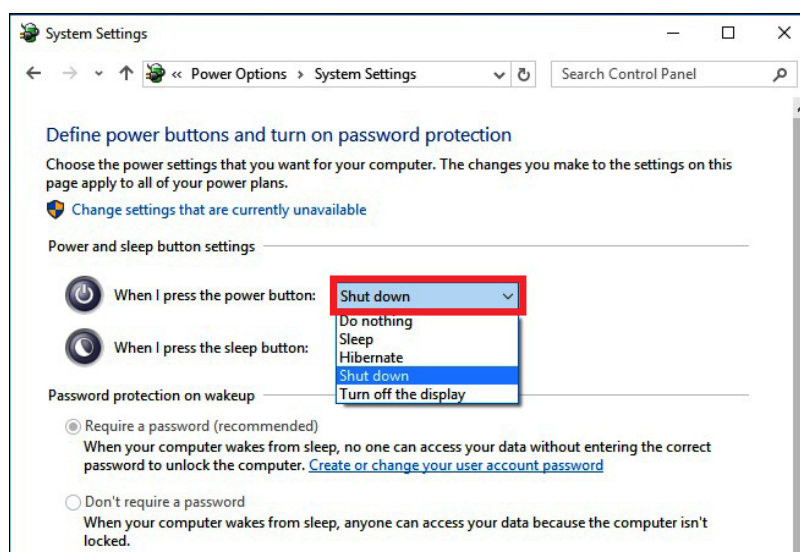

In Windows for example, you need to set "When I press the power button" to Shut down.

# 3

## SYSTEM SETUP

### 3.1 How to Open Your SPC-7000

#### 3.1.1 SPC-7000/7100/7200

**Step 1** Remove four F-M3x4 screws.



**Step 2** Open bottom Cover.





## 3.2 Installing DDR4 SO-DIMM Module

**Step 1** Find DDR4 SO-DIMM socket.

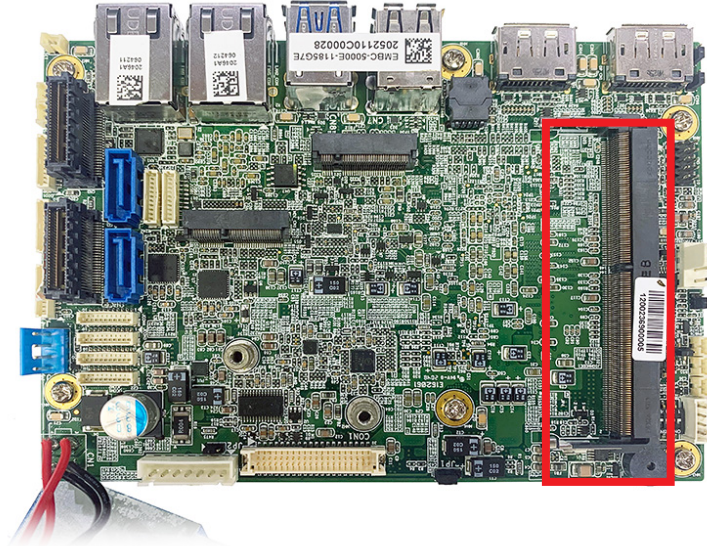

**Step 2** Install DDR4 RAM module into SO-DIMM slot.



**Step 3** Make sure the RAM module is locked by the memory slot.



## 3.3 Installing M.2

### 3.3.1 Key E 2230, Key B 2260

**Step 1** Install M.2 into the M.2 slot.



**Step 2** Fasten one PH-M3x4L screw.



### 3.3.2 Key B 3042

**Step 1** Install M.2 into the M.2Tary, and fasten one PH-M3x4L screw.





### 3.3.3 Key B 3052

**Step 1** Install M.2 into the M.2Tary, and fasten one PH-M3x4L screw.



## 3.4 Installing SSD/HDD

**Step 1** Fasten F M3x4L two screws, and one PH-M3x4L screw.

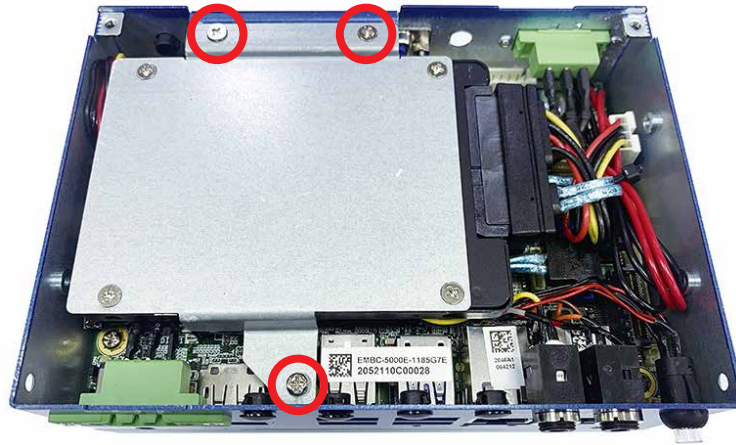

**Step 2** Finished.



## 3.5 Installing SIM Card

**Step 1** Open the SIM card cover.



**Step 2** Install SIM card into to the SIM card slot and then close the SIM card cover.



## 3.6 Installing Antenna Cable

**Step 1** Check antenna cable and washers.



**Step 2** Install antenna cable and then fasten washer and nut.



## 3.7 Mounting Your SPC-7000

### 3.7.1 SPC-7000

Fasten four F-M3x4L screws.

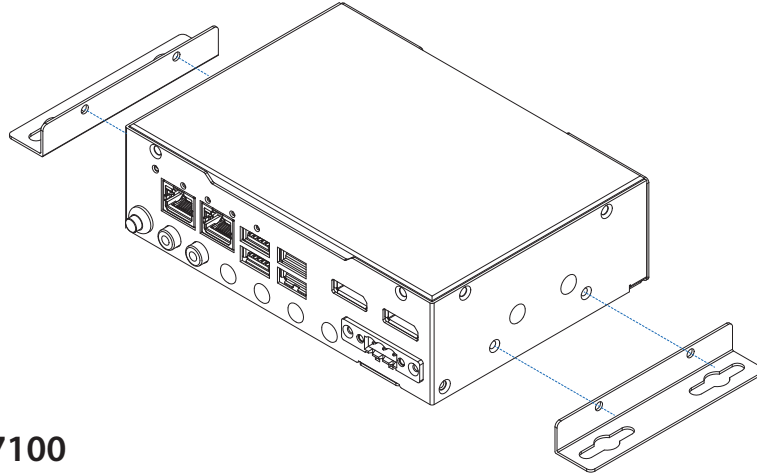

### 3.7.2 SPC-7100

Fasten four F-M3x4 screws.

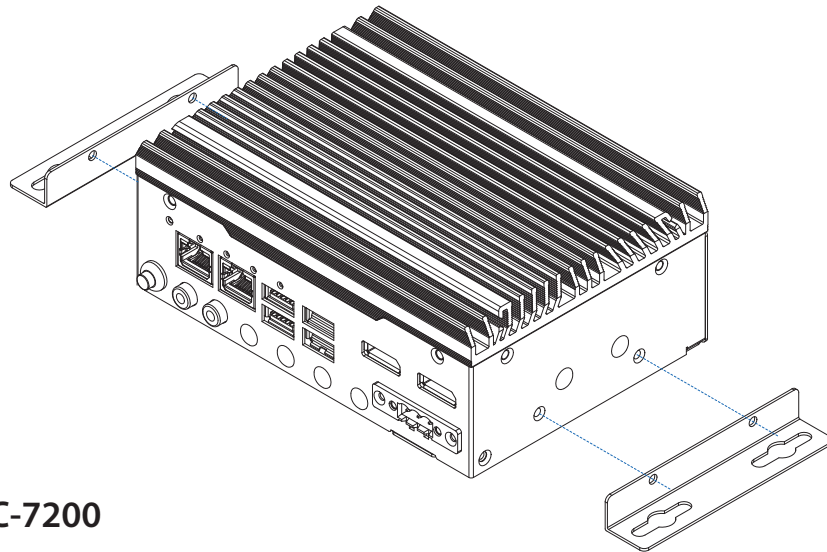

### 3.7.3 SPC-7200

Fasten four F-M3x4L screws.

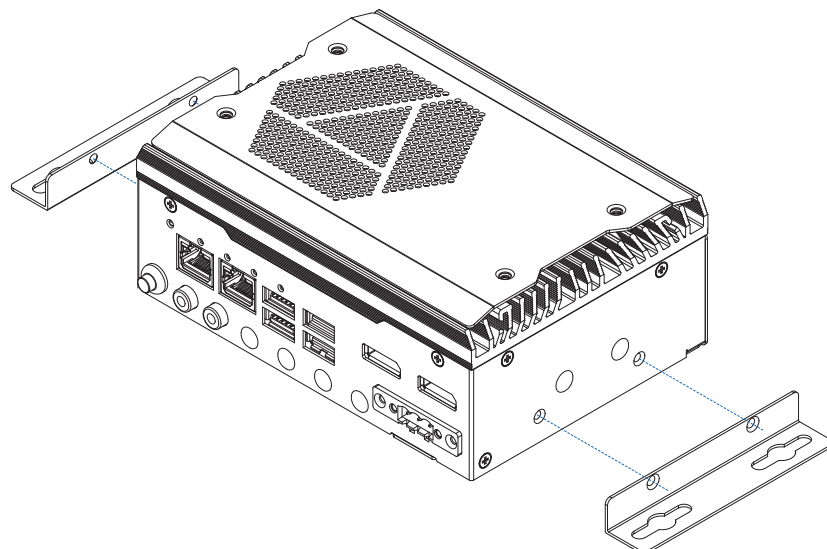



# 4

## BIOS SETUP

### 4.1 BIOS Setting

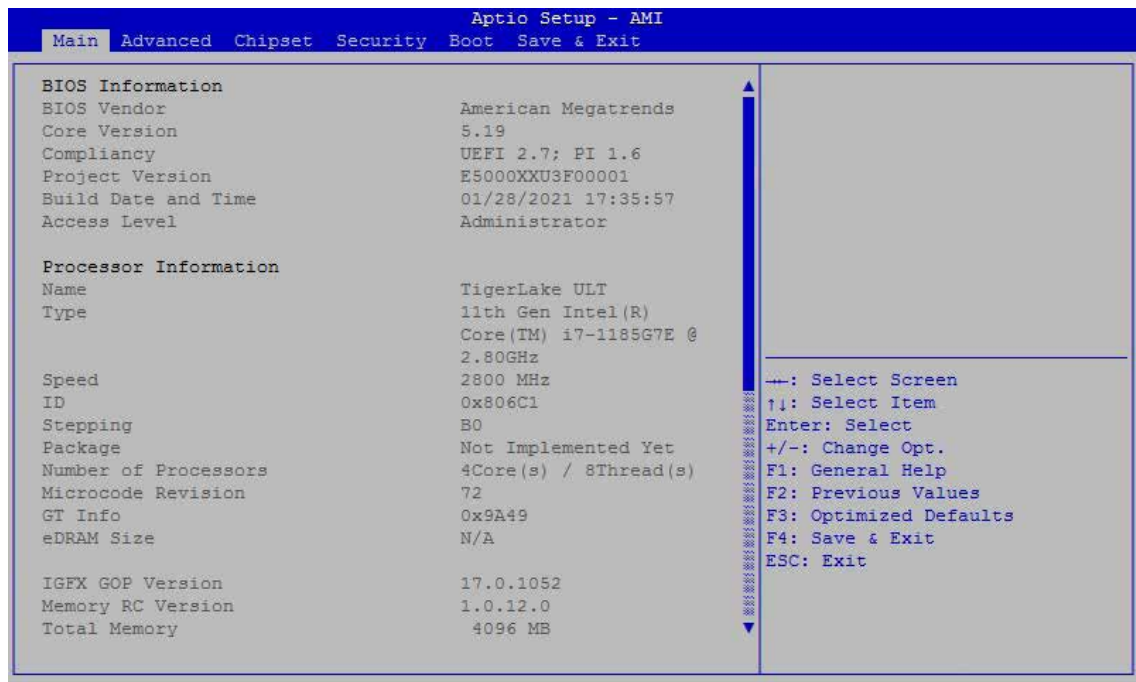

Figure 4-1 : Entering Setup Screen

BIOS provides an interface for users to check and change system configuration. The BIOS setup program is accessed by pressing the <Del> key when POST display output is shown.



## 4.2 Main Menu

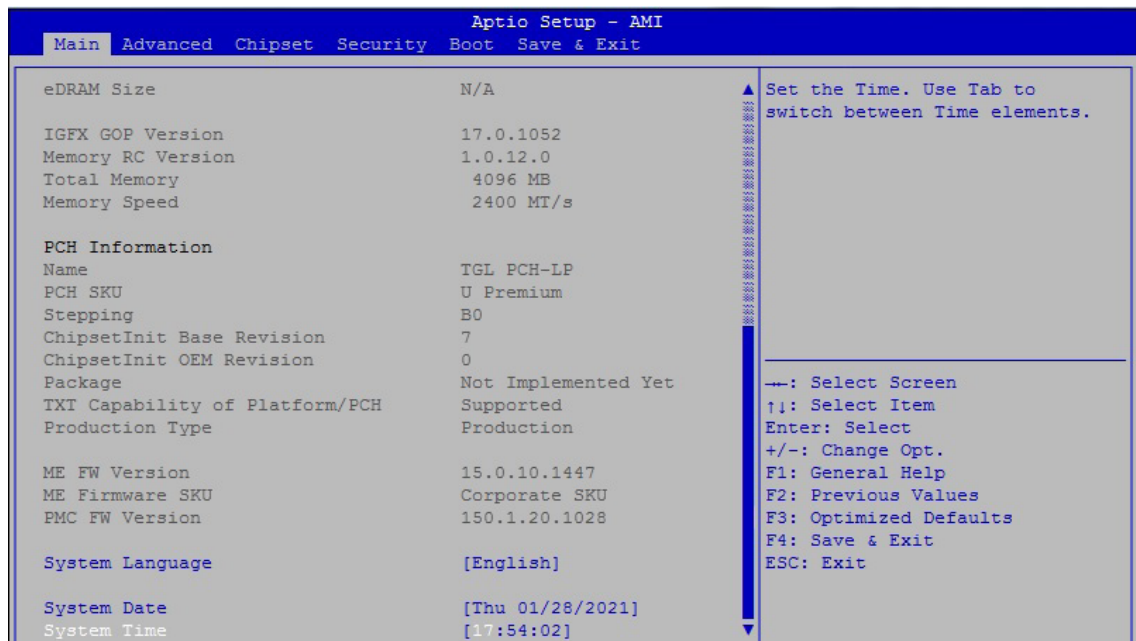

Figure 4-2 : BIOS Main Menu

The main menu displays BIOS version and system information. There are two options on the main menu, system date and system time.

### System Date

Set the date. Use tab to switch between date elements.

### System Time

Set the time. Use tab to switch between time elements.

## 4.3 Advanced Functions

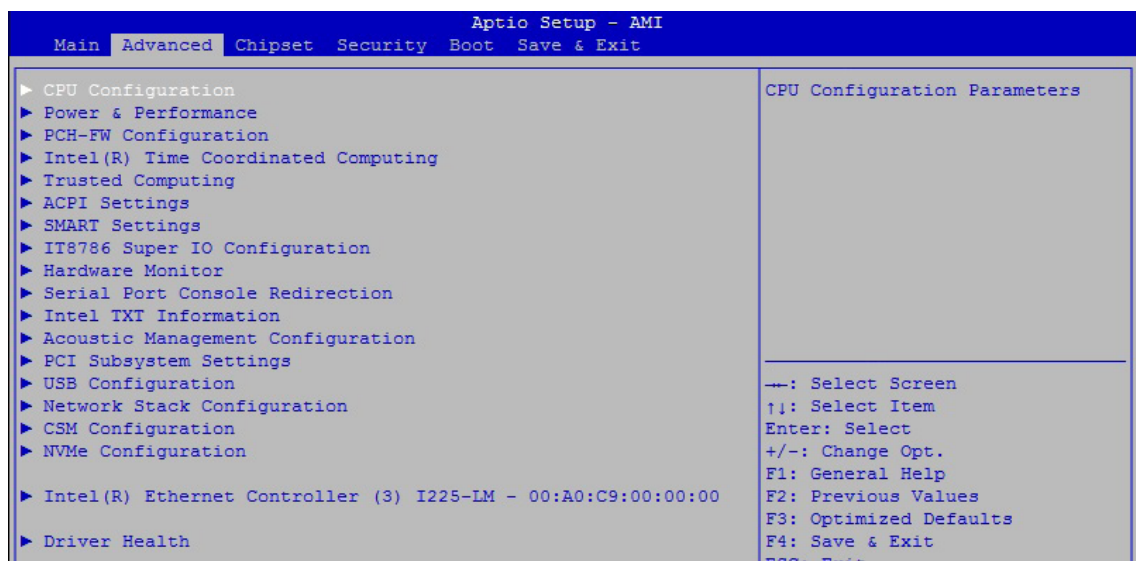

Figure 4-3 : BIOS Advanced Menu

Select advanced tab to enter advanced BIOS setup options such as CPU configuration, SATA configuration, and USB configuration.

### 4.3.1 CPU Configuration

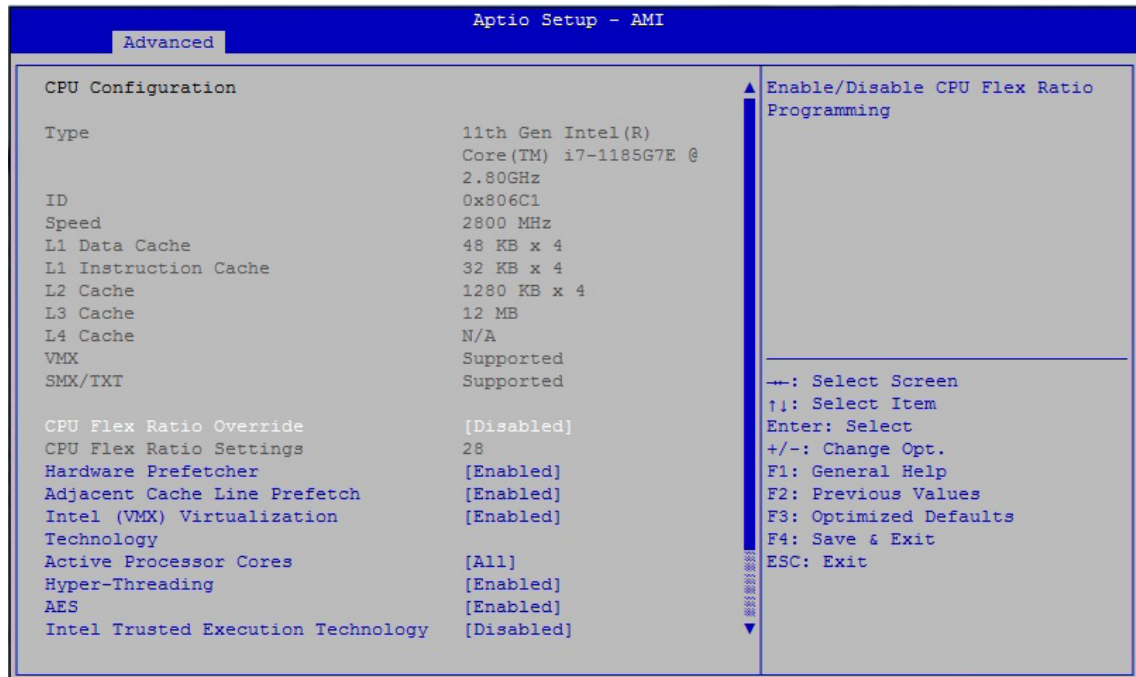

Figure 4-3-1 : CPU Configuration

#### CPU Flex Ratio Override

Enable/Disable CPU Flex Ratio Programming.

#### Hardware Prefetcher

To turn on/off the MLC streamer prefetcher.

#### Adjacent Cache Line Prefetch

To turn on/off prefetching of adjacent cache lines.

#### Intel (VMX) Virtualization Technology

When enabled, a VMM can utilize the additional hardware capabilities provided by Vanderpool Technology.

#### Active Processor Cores

Number of cores to enable in each processor package.

#### Hyper-threading

Enabled or Disabled Hyper-Threading Technology.

#### AES

Enable/disable AES (Advanced Encryption Standard).

#### Intel Trusted Execution Technology

Enables utilization of additional hardware capabilities provided by Intel Trusted Execution Technology.

Changed require a full power cycle to take effect.

#### Total Memory Encryption

Configure Total Memory Encryption (TME) to protect DRAM data from physical attacks. Either the IBEC or the TME can be enabled.

## 4.3.2 Power & Performance

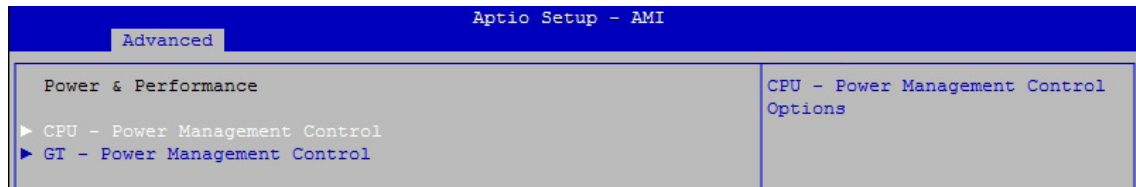

Figure 4-3-2 : Power & Performance

### 4.3.2.1 CPU - Power Management Control

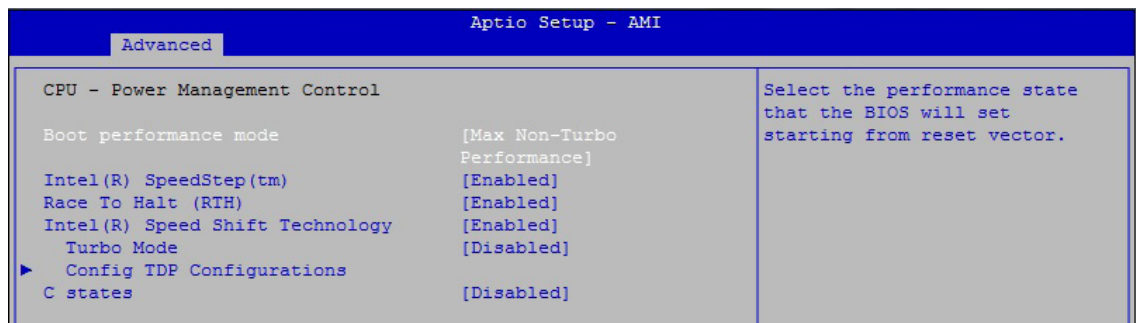

Figure 4-3-2-1 : CPU - Power Management Control

#### Boot performance mode

Select the performance state that the BIOS will set starting from reset vector.

#### Intel® SpeedStep™

Allows more than two frequency ranges to be supported.

#### Race To Halt (RTH)

Enable/Disable Race To Halt feature. RTH will dynamically increase CPU frequency in order to enter pkg C-State faster to reduce overall power. (RTH is controlled through MSR 1FC bit 20).

#### Intel® Speed shift Technology

Enable/Disable Intel® Speed Shift Technology support. Enabling will expose the CPPCv2 interface to allow for hardware controlled P-states.

#### Turbo Mode

Enable/Disable processor Turbo Mode (requires Intel Speed Step or Intel Speed Shift to be available and enabled).

#### Config TDP Configurations

Config TDP Configurations.

#### C states

Enable or disable CPU Power Management. Allows CPU to go to C states when it's no 100% utilized.

#### Enhanced C-states

Enable/disable C1E. When enabled, CPU will switch to minimum speed when all cores enter C-State.

### 4.3.2.2 GT - Power Management Control

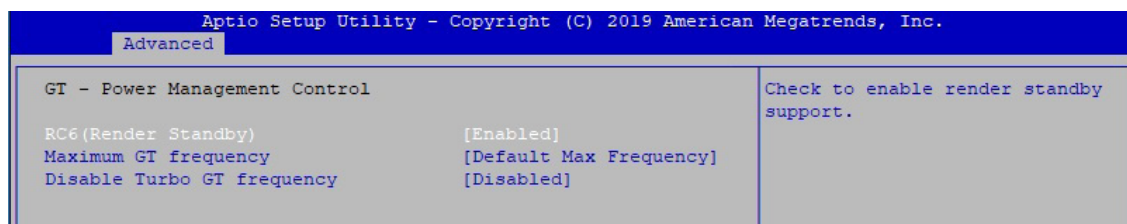

Figure 4-3-2-2 : GT - Power Management Control

#### RC6 (Render Standby)

Check to enable render standby support.

#### Maximum GT frequency

Maximum GT frequency limited by the user. Choose between 300MHz (RPN) and 1150 MHz (RP0). Value beyond the range will be clipped to min/max supported by SKU.

#### Disable Turbo GT frequency

Enabled : Disables Turbo GT frequency. Disabled : GT frequency is not limited.

### 4.3.3 PCH-FW Configuration

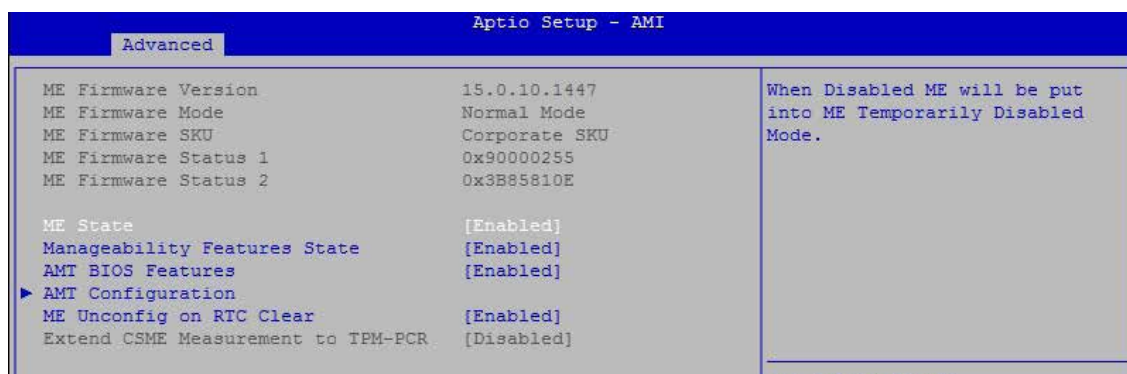

Figure 4-3-3 : PCH-FW Settings

#### ME State

When Disabled ME will be put into ME Temporarily Disabled Mode.

#### Manageability Features State

Enable/Disable Intel(R) Manageability features.

NOTE : This option disables/enables Manageability Features support in FW. To disable support platform must be in an unprovisioned state first.

#### AMT BIOS Features

When disabled AMT BIOS Features are no longer supported and user is no longer able to access MEBx Setup.

Note : This option does not disable Manageability Features in FW.

#### AMT Configuration

Configure Intel Active Management Technology Parameters.

#### ME Unconfig on RTC Clear

Disabling this option will cause ME not be unconfigured on RTC clear.

### 4.3.4 Intel Time Coordinated Computing

Aptio Setup - AMI		
Advanced		
Intel(R) Time Coordinated Computing (Intel(R) TCC)		Enable or Disable Alignment Check Exception (#AC). When enabled, this will assert an #AC when any atomic operation has an operand that crosses two cache lines.
#AC Split Lock	[Disabled]	
Intel(R) TCC Mode	[Disabled]	
Intel(R) TCC Mode Affected Settings		
IO Fabric Low Latency	[Disabled]	
OPIO Recentering	[Enabled]	

Figure 4-3-4 : Intel TCC

Intel® Time Coordinated Computing options.

#### #AC Split Lock

Enable or Disable Alignment Check Exception (#AC). When enabled, this will assert an #AC when any atomic operation has an operand that crosses two cache lines.

#### Intel(R) TCC Mode

Enable or Disable Intel(R) TCC mode. When enabled, this will modify system settings to improve real-time performance. The full list of settings and their current state are displayed below when Intel(R) TCC mode is enabled.

#### IO Fabric Low Latency

Enable or Disable IO Fabric Low Latency. This will turn off some power management in the PCH IO fabrics. This option provides the most aggressive IO Fabric performance setting. S3 state is NOT supported.

#### OPIO Recentering

Enable or Disable Opio Recentering to improve Pcie latency.

### 4.3.5 Trusted Computing

Aptio Setup - AMI		
Advanced		
TPM 2.0 Device Found		Enables or Disables BIOS support for security device. O.S. will not show Security Device. TCG EFI protocol and INT1A interface will not be available.
Firmware Version:	7.85	
Vendor:	IFX	
Security Device Support	[Enable]	
Active PCR banks	SHA256	
Available PCR banks	SHA-1,SHA256	
SHA-1 PCR Bank	[Disabled]	
SHA256 PCR Bank	[Enabled]	
Pending operation	[None]	
Platform Hierarchy	[Enabled]	
Storage Hierarchy	[Enabled]	
Endorsement Hierarchy	[Enabled]	
TPM 2.0 UEFI Spec Version	[TCG_2]	
Physical Presence Spec Version	[1.3]	
TPM 2.0 InterfaceType	[TIS]	
Device Select	[Auto]	
		←: Select Screen ↑↓: Select Item Enter: Select +/-: Change Opt. F1: General Help F2: Previous Values F3: Optimized Defaults

Figure 4-3-5 : Trusted Computing

Control the TPM device status and display related information if TPM chip is present.

### 4.3.6 ACPI Settings

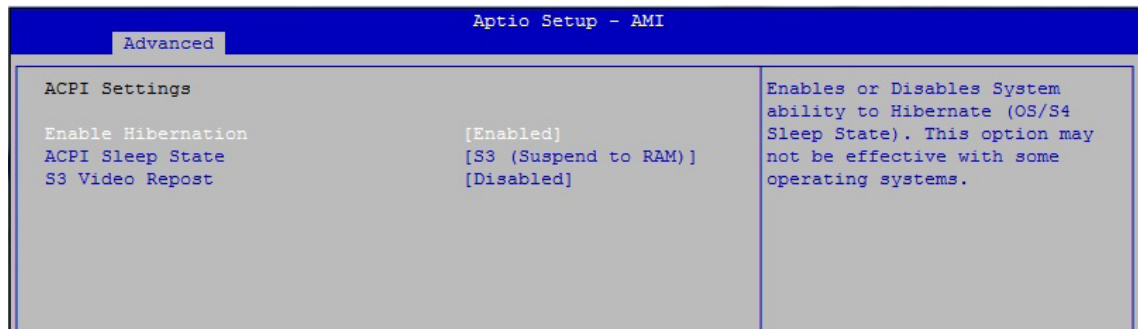

Figure 4-3-6 : ACPI Settings

#### Enable Hibernation :

Enables or Disables System ability to Hibernate (OS/S4 Sleep State). This option may be not effective with some OS.

#### ACPI Sleep State

Select the highest ACPI sleep state the system will enter when the SUSPEND button is pressed.

#### S3 Video Repost

Enable or Disable S3 Video Repost.

### 4.3.7 SMART Settings

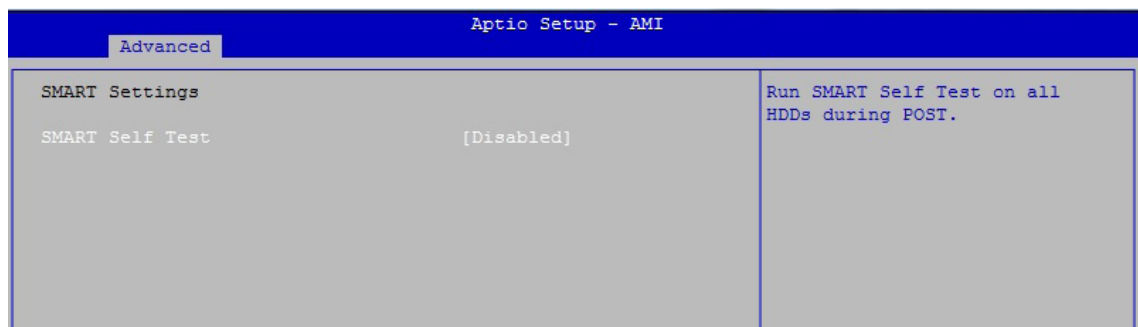

Figure 4-3-7 : SMART Settings

#### SMART Self Test

Run SMART Self-test on all HDDs during POST.



## 4.3.8 IT8786 Super IO Configuration

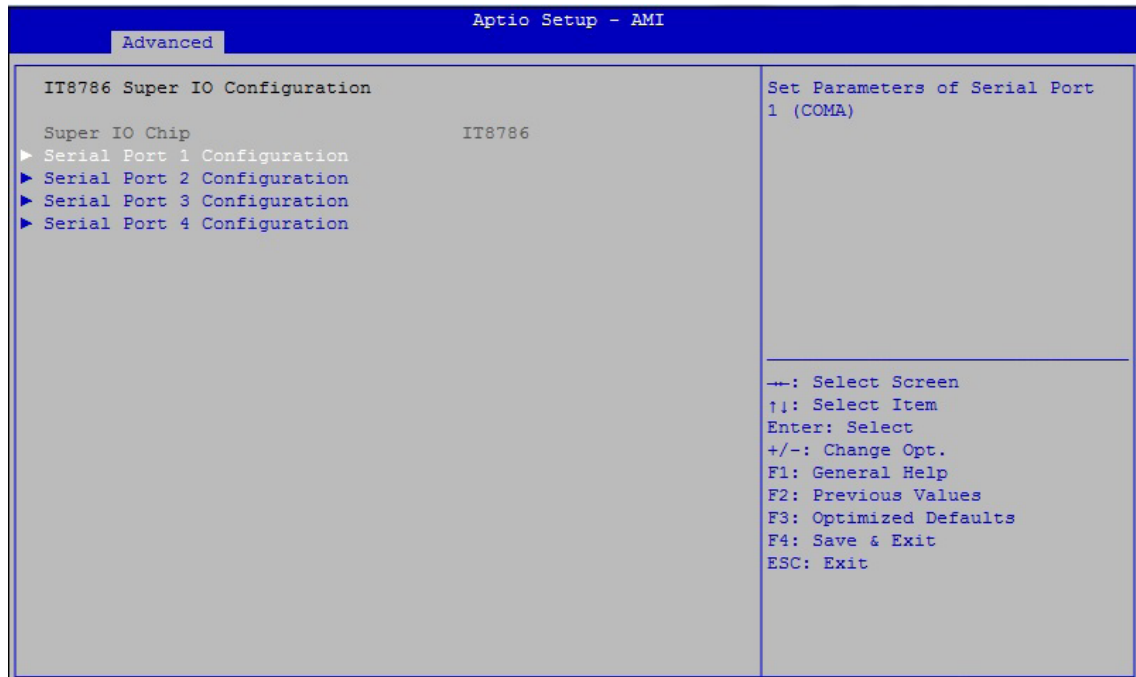

Figure 4-3-8 : Super IO Settings

### Serial Port 1 Configuration

Set Parameters of Serial Port 1 (COM1).

### Serial Port 2 Configuration

Set Parameters of Serial Port 2 (COM2).

### Serial Port 3 Configuration

Set Parameters of Serial Port 3 (COM3).

### Serial Port 4 Configuration

Set Parameters of Serial Port 4 (COM4).

## 4.3.9 Hardware Monitor

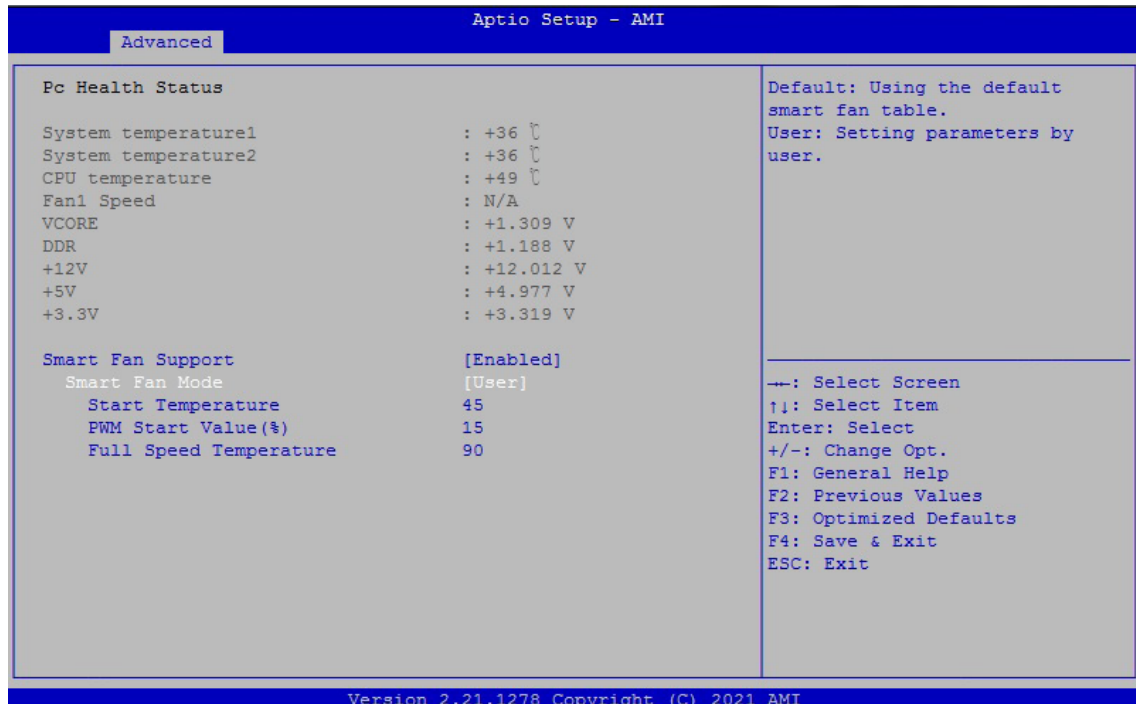

Figure 4-3-9 : Hardware Monitor Settings

The IT8786 SIO features an enhanced hardware monitor providing thermal, fan speed, and system voltages' status monitoring.

### Smart Fan Support

Smart Fan Support. Work with full Speed if "Smart Fan Support" is Disabled.

### Smart Fan Mode

Default : Using the default smart fan table.  
User : Setting parameters by user.

### Start Temperature

Temperature Limit value of Fan Start (Degree C).  
(Range : 10-80)

### PWM Start Value (%)

Default PWM Value of Fan.  
(Range : 15%-100%)

### Full Speed Temperature

Temperature Limit value of Fan Full Speed (Degree C).  
(Range : 50-90)



### 4.3.10 Serial Port Console Redirection

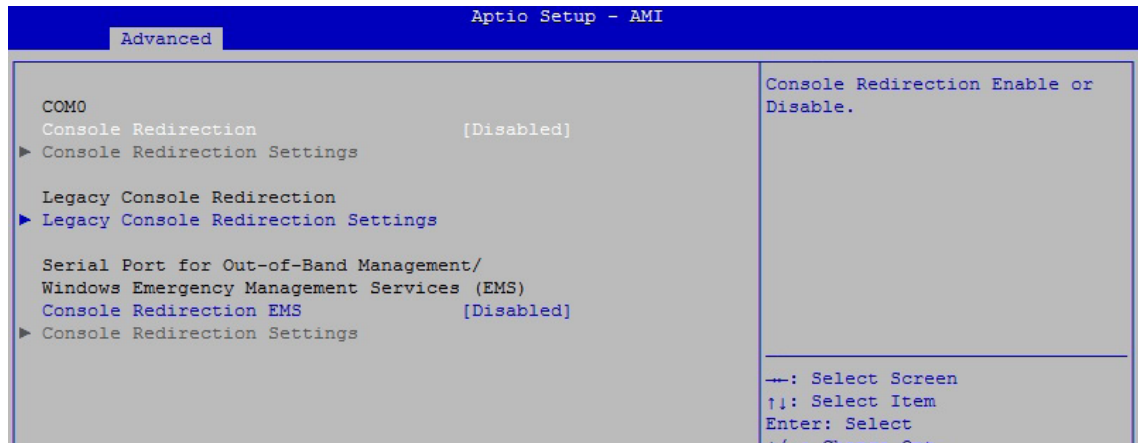

Figure 4-3-10 : Serial Port Console Redirection Settings

#### Console Redirection

Console Redirection Enable or Disable.

#### Console Redirection Settings

The settings specify how the host computer and the remote computer (which the user is using) will exchange data. Both computers should have the same or compatible settings.

#### Legacy Console Redirection Settings

Legacy Console Redirection Settings

#### Serial Port for Out-of-Band management/Windows Emergency Management Services (EMS)

Console Redirection Enable or Disable.

### 4.3.11 Intel TXT Information

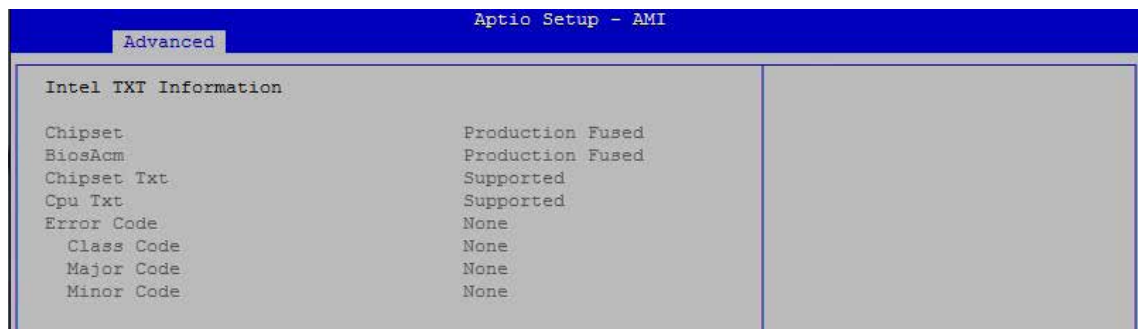

Figure 4-3-11 : Intel TXT Information

Display Intel TXT information.

## 4.3.12 Acoustic Management Configuration

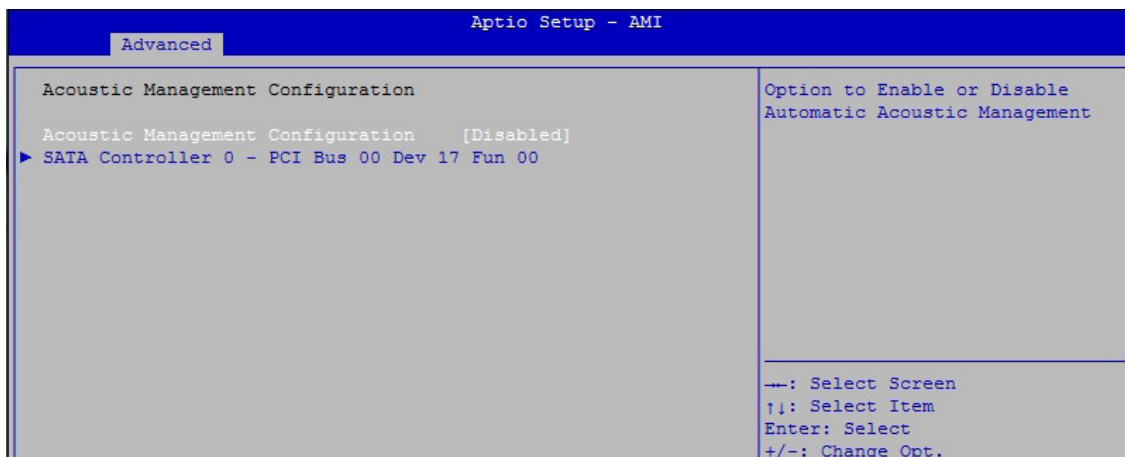

Figure 4-3-12 : Acoustic Management Settings

### Acoustic Management Configuration

Option to Enable or Disable Automatic Acoustic Management.

## 4.3.13 PCI Subsystem Settings

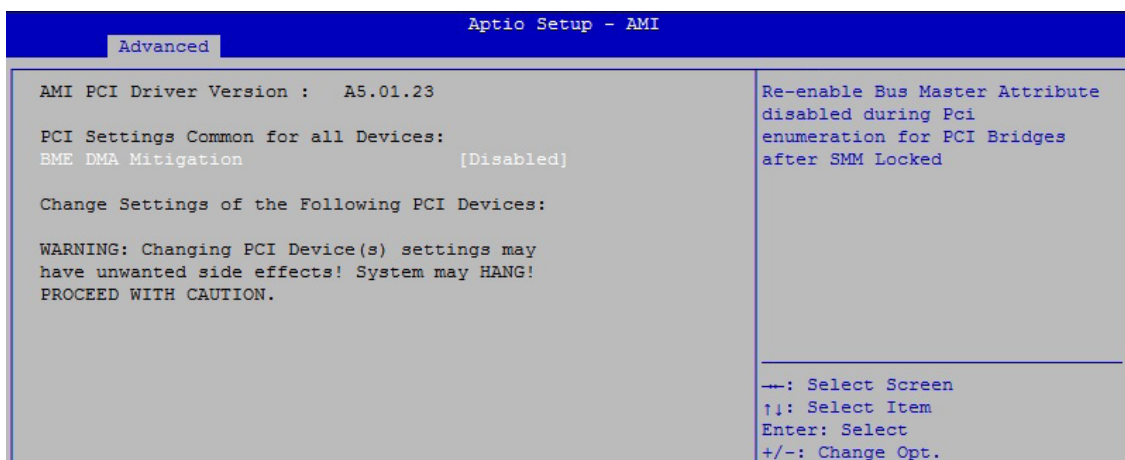

Figure 4-3-13 : PCI Subsystem Settings

### BME DMA Mitigation

Re-enable Bus Master Attribute disabled during Pci enumeration for PCI Bridges after SMM Locked.

## 4.3.14 USB Configuration

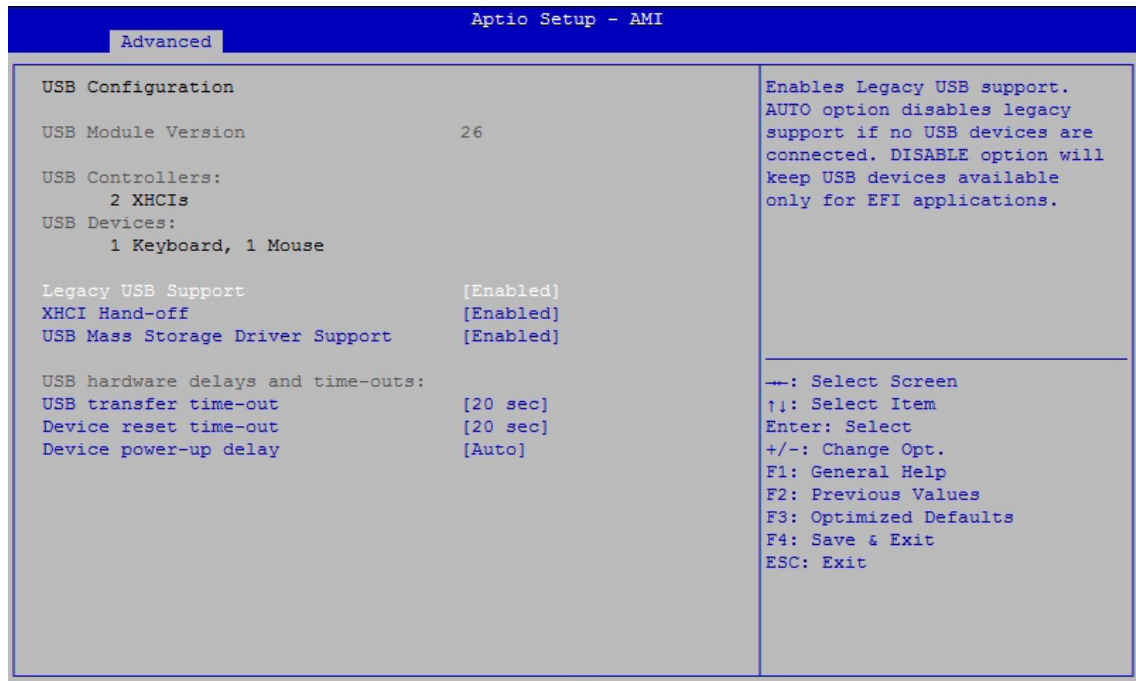

Figure 4-3-14 : USB Settings

### Legacy USB Support

Enables Legacy USB support.

AUTO option disables legacy support if no USB devices are connected. DISABLE option will keep USB devices available only for EFI applications.

### XHCI Hand-off

This is a workaround for OSES without XHCI hand-off support. The XHCI ownership change should be claimed by XHCI driver.

### USB Mass Storage Driver Support

Enable/disable USB Mass storage driver support.

### USB transfer time-out

The time-out value for control, bulk, and Interrupt transfers.

### Device reset time-out

USB mass storage device start unit command time-out.

### Device power-up delay

Maximum time the device will take before it properly reports itself to the host controller. 'Auto' uses default value : for a root port it is 100ms, for a hub port the delay is taken from hub descriptor.

### 4.3.15 CSM Configuration

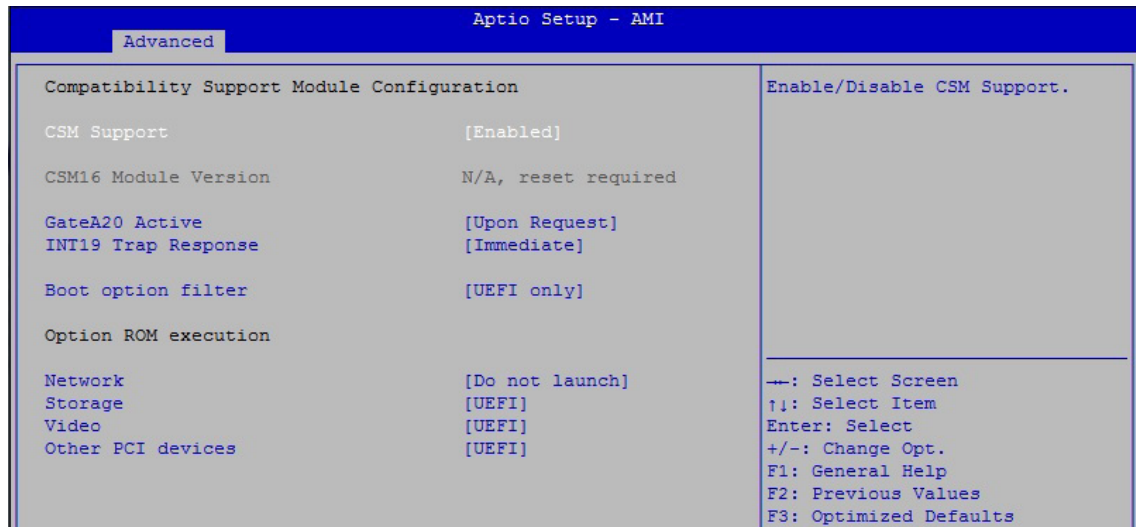

Figure 4-3-15 : CSM Settings

#### CSM Support

Enable/disable CSM support.

#### GateA20 Active

UPON REQUEST-GA20 can be disabled using BIOS services.

ALWAYS-do not allow disabling GA20; this option is useful when any RT code is executed above 1MB.

#### Option ROM Messages

Set display mode for option ROM.

#### INT19 Trap Response

BIOS reaction on INT19 trapping by option ROM :  
IMMEDIATE - execute the trap right away;  
POSTPONED - execute the trap during legacy boot.

#### Boot option filter

This option controls Legacy/UEFI ROM's priority.

#### Network

Controls the execution of UEFI and Legacy PXE OpROM.

#### Storage

Controls the execution of UEFI and Legacy storage OpROM.

#### Video

Controls the execution of UEFI and Legacy video OpROM.

#### Other PCI devices

Determines OpROM execution policy for devices other than network, storage, or video.

### 4.3.16 NVMe Configuration

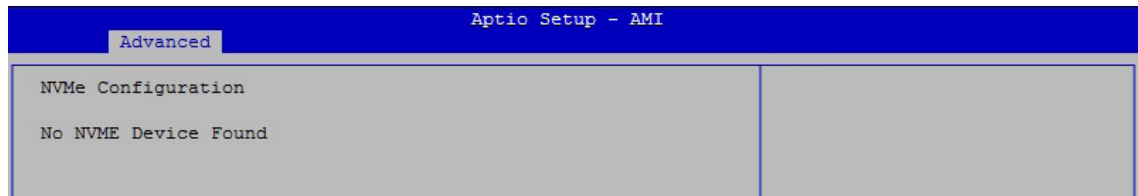

Figure 4-3-16 : NVMe Configuration

Display NVMe Controller and drive information.

### 4.3.17 Network Stack Configuration

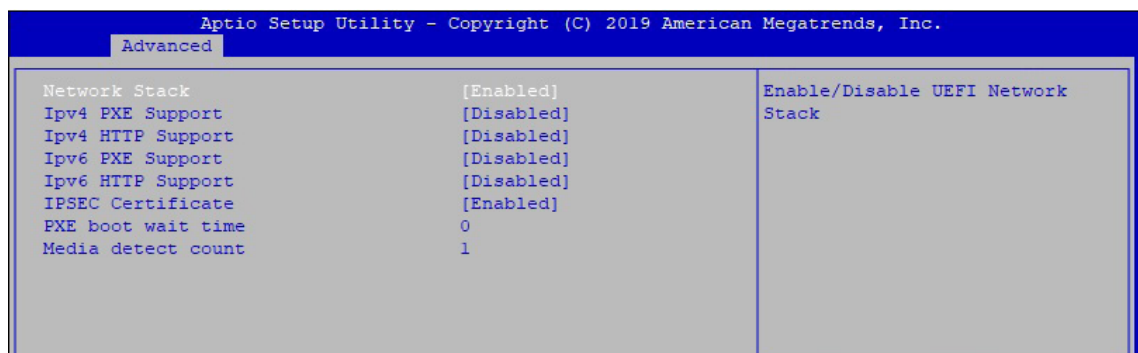

Figure 4-3-17 : Network Stack Configuration

#### Network Stack

Enable/Disable UEFI Network Stack.

#### Ipv4 PXE Support

Enable/disable IPv4 PXE boot support.

#### Ipv4 HTTP Support

Enable/disable IPv4 HTTP boot support.

#### Ipv6 PXE Support

Enable/disable IPv6 PXE boot support.

#### Ipv6 HTTP Support

Enable/disable IPv6 HTTP boot support.

#### PXE boot wait time

Wait time to press ESC key to abort the PXE boot.

#### Media detect count

Number of times presence of media will be checked.

## 4.4 Chipset Functions

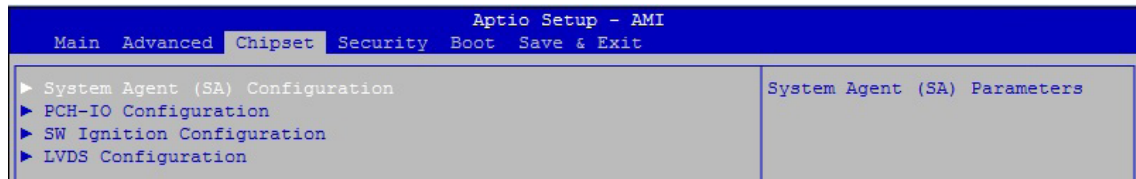

Figure 4-4 : BIOS Chipset Menu

### System Agent (SA) Configuration

System agent (SA) parameters.

### PCH-IO Configuration

PCH parameters.

### SW Ignition Configuration

SW Ignition Configuration. Settings Delay Timer and value of Voltage limit.

### 4.4.1 System Agent (SA) Configuration

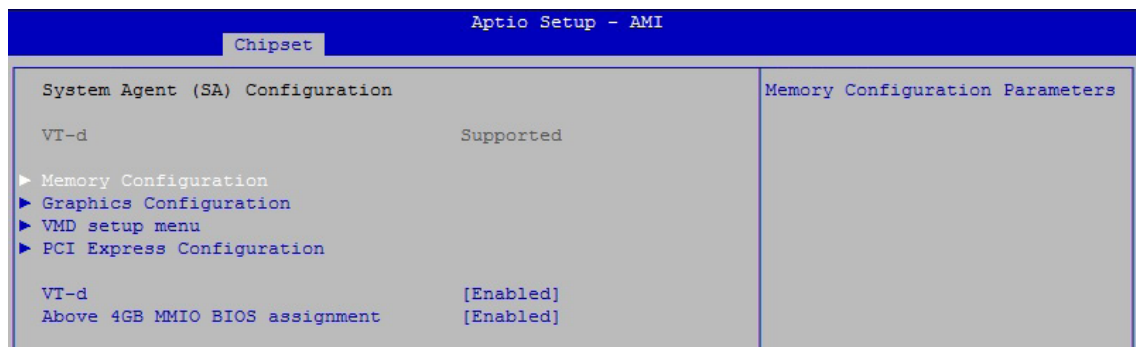

Figure 4-4-1 : System Agent Settings

#### VT-d

VT-d capability.

#### Above 4GB MMIO BIOS assignment

Enable/Disable above 4GB MemoryMappedIO BIOS assignment. This is disabled automatically when Aperture Size is set to 2048MB.

### 4.4.1.1 Memory Configuration



Figure 4-4-1-1 : Memory Information

Display memory information.

#### In-Band ECC Support

Enable/Disable In-Band ECC. Either the IBECC or the TME can be enabled.

## 4.4.1.2 Graphics Configuration

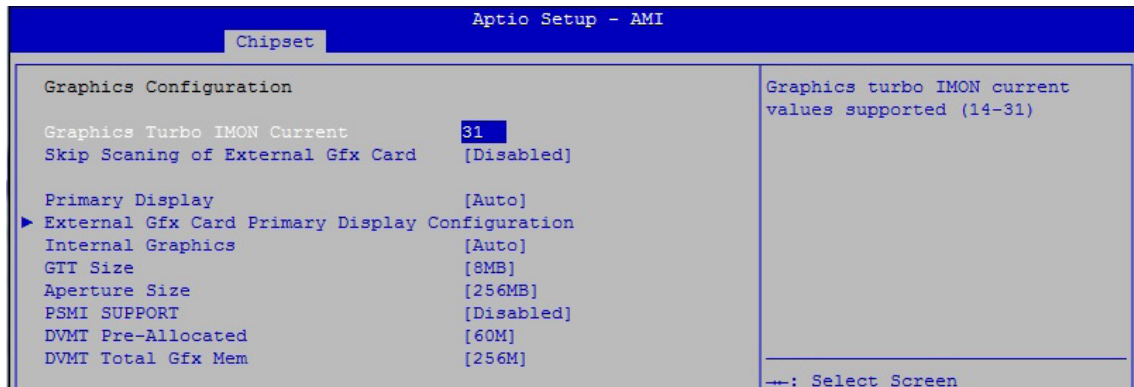

Figure 4-4-1-2 : Graphics Settings

### Graphics Configuration

Graphics turbo IMON current values supported (14-31).

### Skip Scanning of External Gfx Card

If Enable, it will not scan for External Gfx Card on PEG and PCH PCIE ports.

### Primary Display

Select which of IGFX/PEG/PCI graphics device should be Primary Display or select HG for Hybrid Gfx.

### Internal Graphics

Keep IGFX enabled based on the setup options.

### GTT Size

Select the GTT size.

### Aperture Size

Select the aperture size.

Note : Above 4GB MMIO BIOS assignment is automatically enabled when selecting 2048MB aperture. To use this feature, please disable CSM support.

### PSMI SUPPORT

PSMI Enable/Disable.

### DVMT Pre-Allocated

Select DVMT 5.0 pre-allocated (fixed) graphics memory size used by the internal graphics device.

### DVMT Total Gfx Mem

Select DVMT5.0 total graphic memory size used by the internal graphics device.

### 4.4.1.3 VMD Configuration

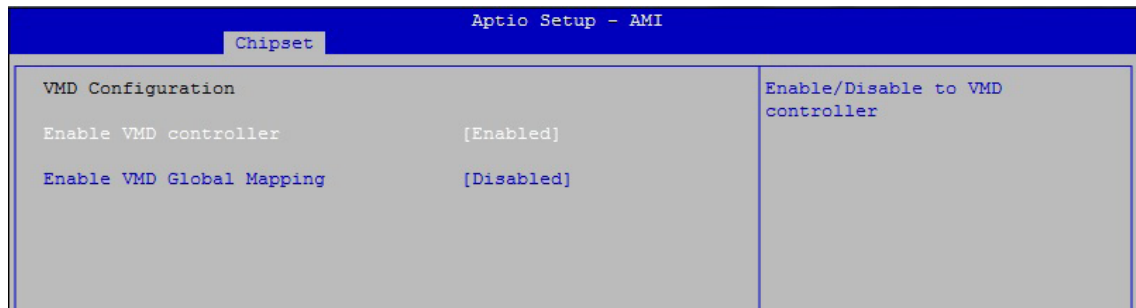

Figure 4-4-1-3 : VMD Configuration

#### Enable VMD controller

Enable/Disable to VMD controller.

#### Enable VMD Global Mapping

Enable/Disable to VMD Global Mapping.

### 4.4.1.4 SA PCI Express Configuration

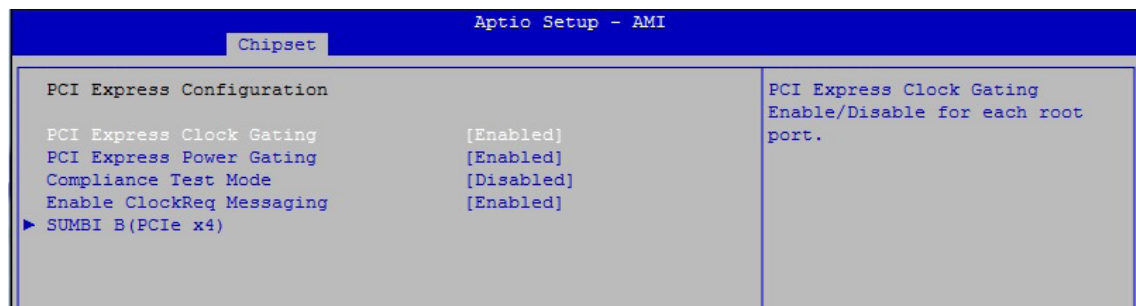

Figure 4-4-1-4 : SA PCI Express Configuration

#### PCI Express Clock Gating

PCI Express Clock Gating Enable/Disable for each root port.

#### PCI Express Power Gating

PCI Express Power Gating Enable/Disable for each root port.

#### Compliance Test Mode

Enable when using Compliance Load Board.

#### Enable ClockReq Messaging

Enable or Disable ClockReq Messaging.

#### SUMIT B (PCIe x4)

BIOS options for PCI Express device setting.



## 4.4.2 PCH-IO Configuration

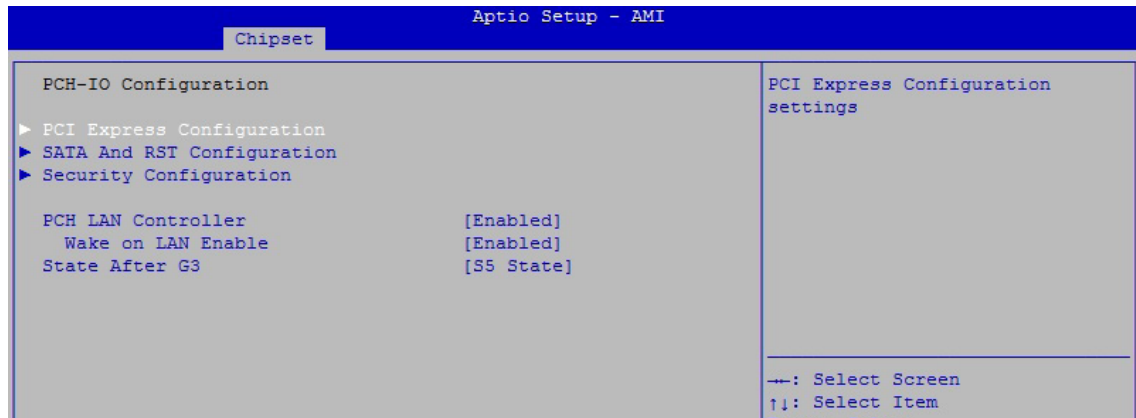

Figure 4-4-2 : PCH-IO Settings

### PCH LAN Controller

Enable or disable onboard NIC.

### Wake on LAN

Enable or disable integrated LAN to wake the system.

### State After G3

Specify what state to go to when power is re-applied after a power failure (G3 state).

S0 State: Always turn-on the system when power source plugged-in.

S5 State: Always turn-off the system when power source plugged-in.

## 4.4.2.1 PCI Express Configuration

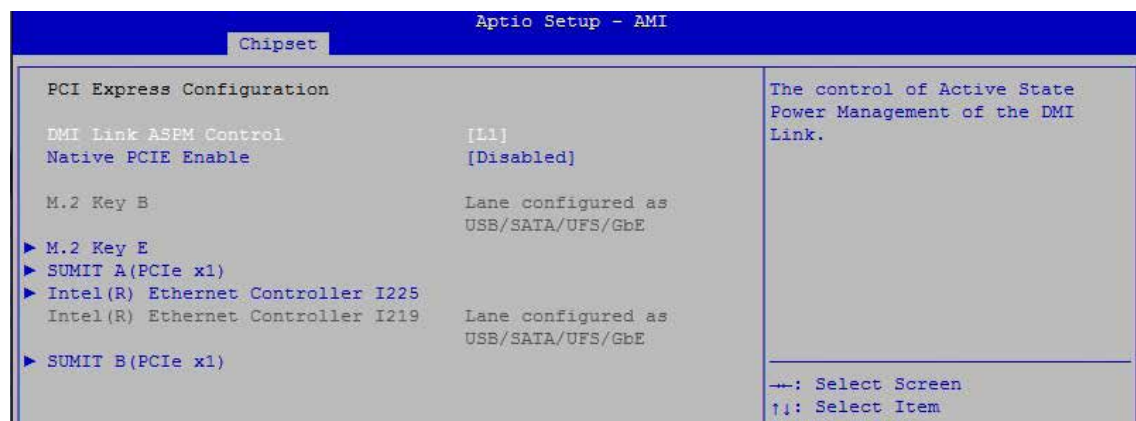

Figure 4-4-2-1 : PCI Express Configuration

### DMI Link ASPM Control

The control of Active State Power Management of the DMI Link.

### Native PCIe Enable

PCI Express Native Support Enable/Disable. This feature is available in Vista and beyond Windows OS.

### PCI Express device settings

BIOS options for PCI Express device setting.

## 4.4.2.2 SATA And RST Configuration

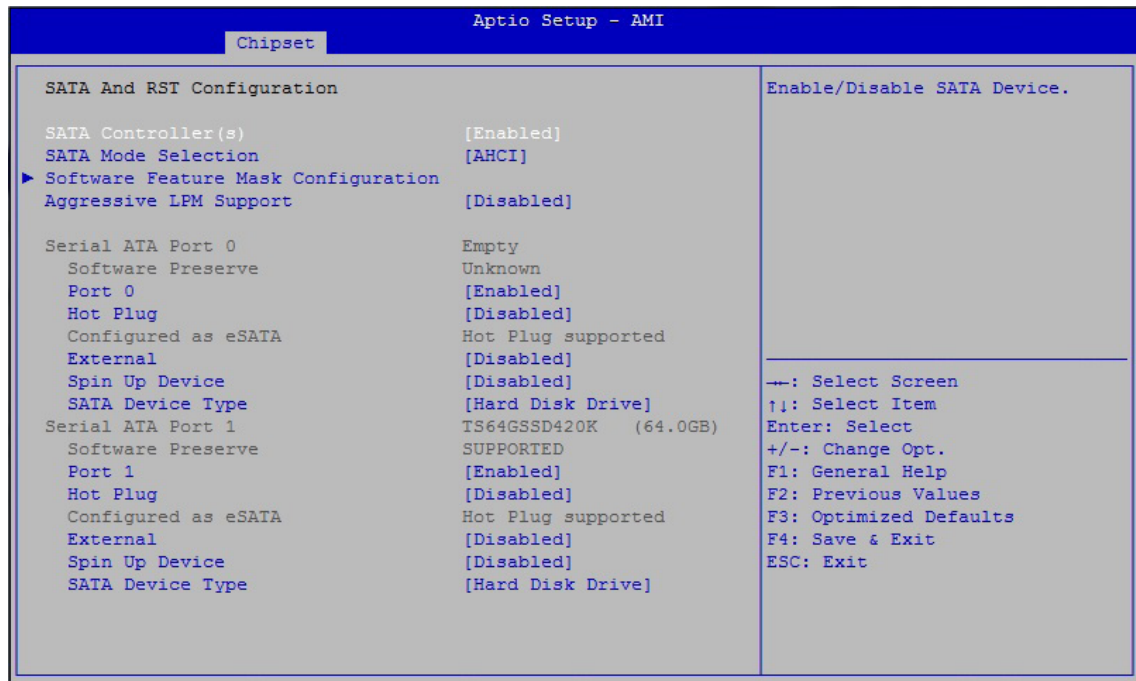

Figure 4-4-2-2 : SATA Devices Settings

### SATA Controller(s)

Enable or disable SATA Device.

### SATA Mode Selection

Determines how SATA controllers operate.

### Software Feature Mask Configuration

RST Legacy OPROM/RST UEFI driver will refer to the SWFM configuration to enable/disable the storage features.

### Aggressive LPM Support

Enable PCH to aggressively enter link power state.

### Options for each SATA port.

#### Port n

Enable or disable SATA port.

#### Hot Plug

Designates this port as Hot Pluggable.

#### Spin Up Device

On an edge detect from 0 to 1, the PCH starts a COMRESET initialization sequence to the device.

#### SATA Device Type

Identify the SATA port is connected to Solid State Drive or Hard Disk Drive.

### 4.4.2.3 BIOS Security Configuration of PCH-IO

Aptio Setup - AMI		
Chipset		
Security Configuration		Enable/Disable the PCH BIOS Lock Enable feature. Required to be enabled to ensure SMM protection of flash.
BIOS Lock	[Enabled]	
Force unlock on all GPIO pads	[Disabled]	

Figure 4-4-2-3 : BIOS Security Settings

#### BIOS Lock

Enable/disable the PCH BIOS lock enable (BLE bit) feature.

#### Force unlock on all GPIO pads

If Enabled BIOS will force all GPIO pads to be in unlocked state.

### 4.4.3 SW Ignition Configuration

Aptio Setup - AMI		
Chipset		
SW Ignition Configuration		Voltage Guard enable or disable, only effect on Ignition mode.
Ignition F/W Version	00.05	
Current Ignition control method	[Hardware]	
System power on method	[Ignition]	
Delay On Timer (Seconds)	0	
Delay Off Timer (Seconds)	5	
Force Shutdown Timer (Minutes)	1	
Voltage Guard	[Enabled]	
Voltage Guard Lower limit value	9	
Voltage Guard higher limit value	15	

Figure 4-4-3 : PCH-IO Settings

#### System power on method

[Normal] System power on by power button.

[Ignition] System power on by ignition pin.

#### Delay On Timer (Seconds)

The delay time after user trigger ignition on signal (Seconds).

#### Delay Off Timer (Seconds)

The delay time after user trigger ignition off signal (Seconds).

#### Force Shutdown Timer (Minutes)

Used to force cut off system power when OS unable gracefully shutdown system successfully.

#### Voltage Guard

Voltage Guard enable or disable, only effect on Ignition mode.

#### Voltage Guard Lower limit value

Voltage Guard lower limit value setting. Range : 9v – 40v.

#### Voltage Guard higher limit value

Voltage Guard Higher limit value setting. Range : 15v – 55v.

## 4.4.4 LVDS Configuration

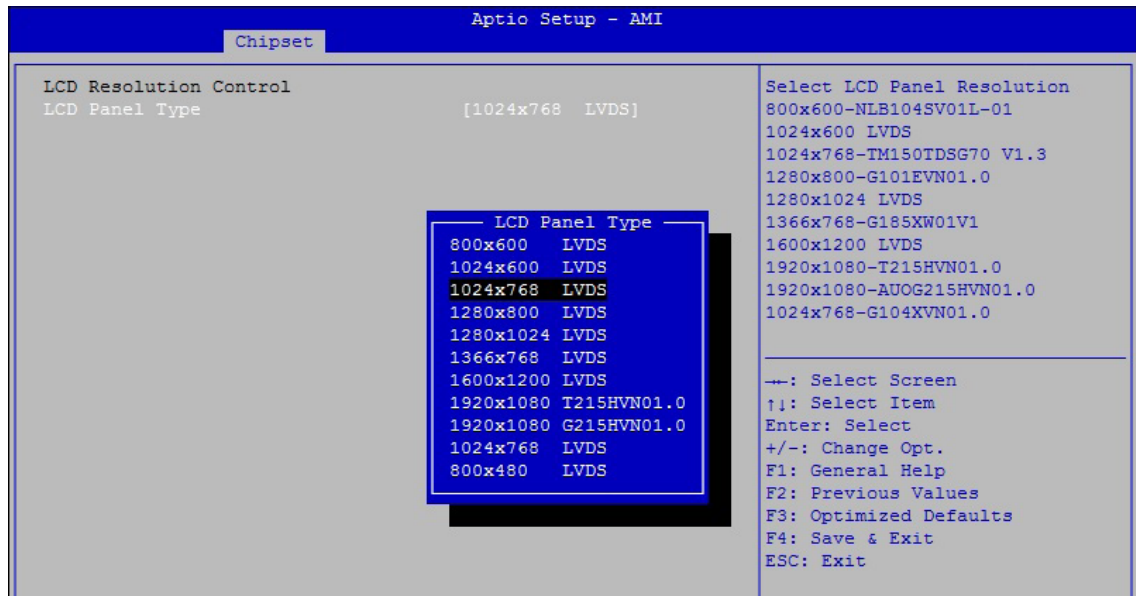

Figure 4-4-4 : LVDS Panel Settings

The LVDS Configuration option will be present if LVDS panel is connected on system.

### LCD Panel Type

Select LCD Panel Resolution.

## 4.5 Security

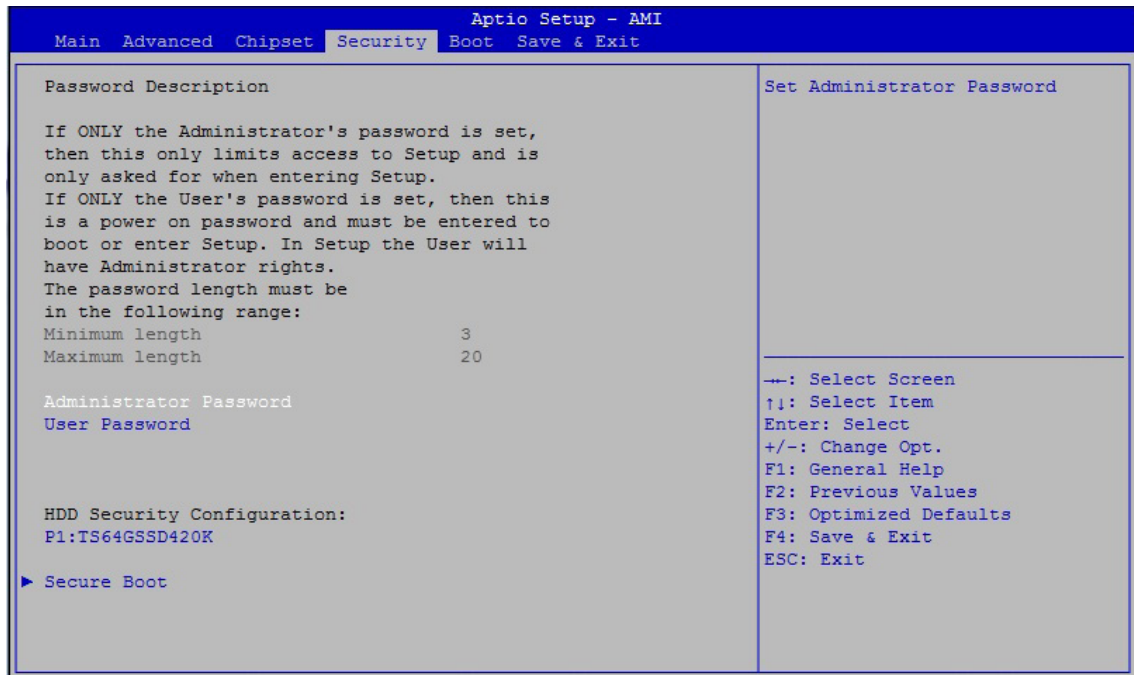

Figure 4-5 : BIOS Security Menu

### Administrator Password

Set administrator password.

### User Password

Set user password.

### Secure Boot

Secure Boot configuration.

## 4.5.1 HDD Security Configuration

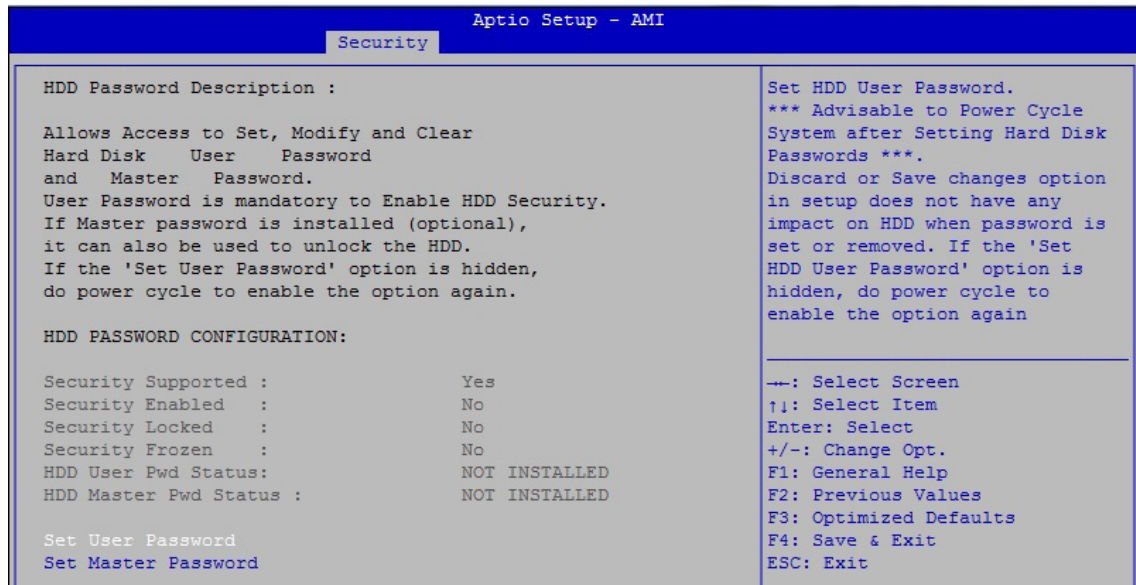

Figure 4-5-1 : HDD Security Settings

### Set User Password

Set HDD user password.

\*\*\* Advisable to power cycle system after setting hard disk passwords\*\*\*.

Discard or save changes option in setup does not have any impact on HDD when password is set or removed. If the 'Set HDD user Password' option is gray, do power cycle to enable the option again.

## 4.5.2 Security Boot



Figure 4-5-2 : Security Boot Settings

### Secure Boot

Secure Boot feature is Active if Secure Boot is Enabled, Platform Key (PK) is enrolled and the System is in User mode. The mode change requires platform reset.

### Secure Boot Mode

Secure Boot mode options : Standard or Custom.

In Custom mode, Secure Boot Policy variables can be configured by a physically present user without full authentication.

### Key Management

Enables expert users to modify Secure Boot Policy variables without full authentication.

## 4.6 Boot Functions

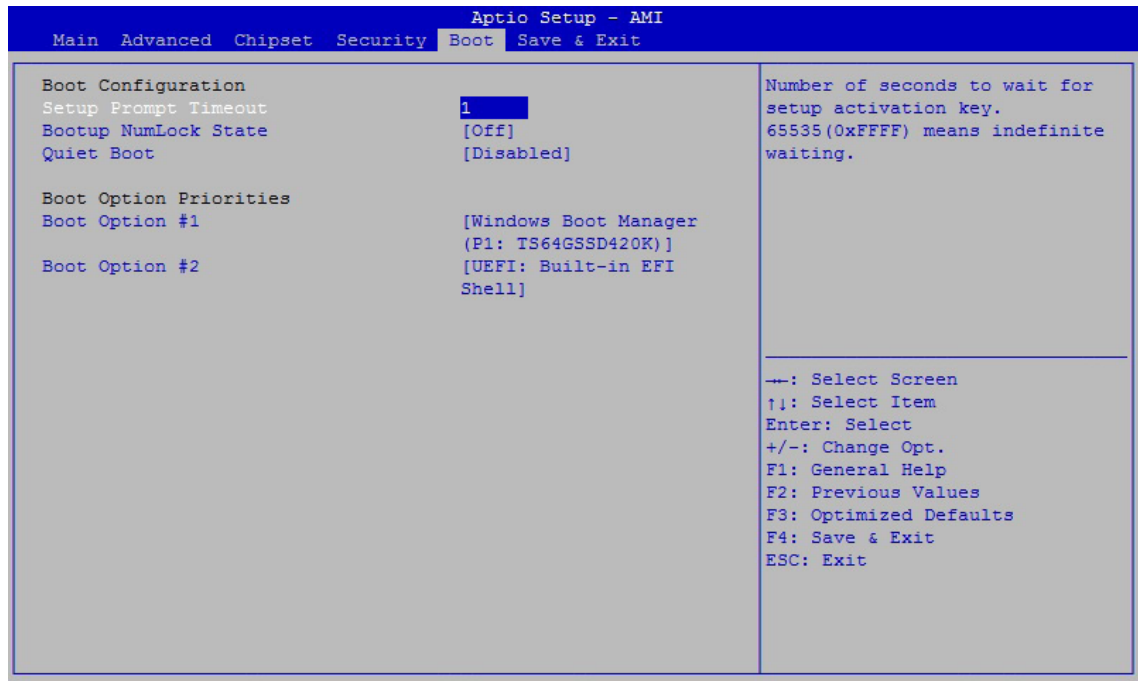

Figure 4-6 : BIOS Boot Menu

### Setup Prompt Timeout

Number of seconds to wait for setup activation key. 65535(0xFFFF) means indefinite waiting.

### Bootup NumLock State

Select the keyboard NumLock state.

### Quiet Boot

Enables or disables Quiet Boot option.

### Boot Option #x

Sets the system boot order.



## 4.7 Save & Exit

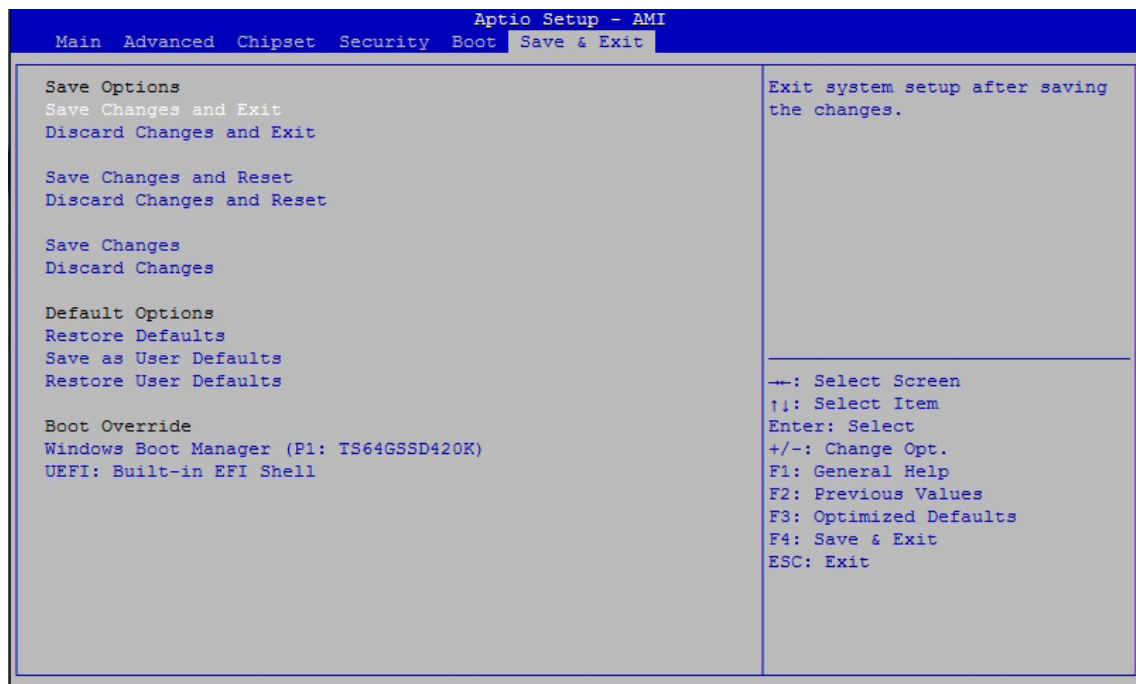

Figure 4-7 : BIOS Save and Exit Menu

### Save Changes and Exit

Exit system setup after saving the changes.

### Discard Changes and Exit

Exit system setup without saving any changes.

### Save Changes and Reset

Reset the system after saving the changes.

### Discard Changes and Reset

Reset system setup without saving any changes.

### Save Changes

Save Changes done so far to any of the setup options.

### Discard Changes

Discard Changes done so far to any of the setup options.

### Default Options :

#### Restore Defaults

Restore/Load Default values for all the setup options.

#### Save as User Defaults

Save the changes done so far as User Defaults.

#### Restore User Defaults

Restore the User Defaults to all the setup options.



# A

## APPENDIX A : GPIO GUIDE

### A.1 Function Description

The SPC-7000 offers a 16-bit GPIO a pair of 10-bit internal connector, and a watchdog timer.

GPIO definition is shown below :

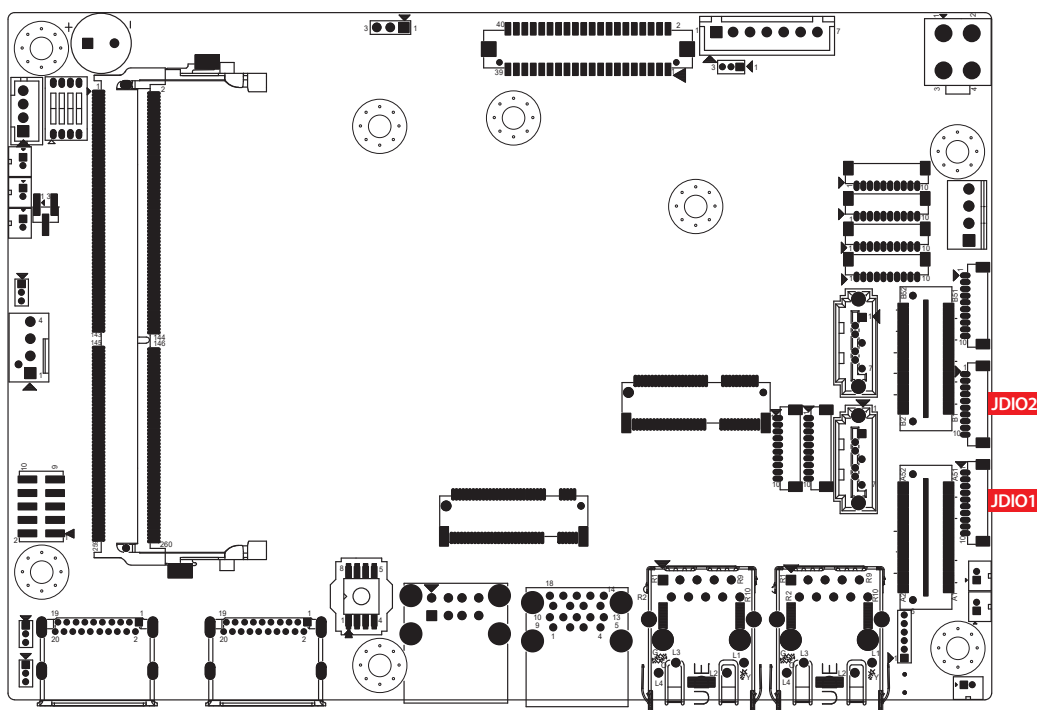

JDIO1		JDIO2	
Pin No.	GPIO Definition	Pin No.	GPIO Definition
1	SIO_GPI80	1	SIO_GPO70
2	SIO_GPI81	2	SIO_GPO71
3	SIO_GPI82	3	SIO_GPO72
4	SIO_GPI83	4	SIO_GPO73
5	SIO_GPI84	5	SIO_GPO74
6	SIO_GPI85	6	SIO_GPO75
7	SIO_GPI86	7	SIO_GPO76
8	SIO_GPI87	8	SIO_GPO77
9	+3.3V	9	+3.3V
10	GND	10	GND

## A.2 Software Package Contain

Distribution folders include x32 and x64 versions, use the batch file for driver installation.

There are included as followed :

Win10\_32.bat, and Win10\_64.bat :

Installation for driver, and

Uninstall\_32.bat, and Uninstall\_64.bat :

Uninstallation for driver

Run batch file as Administrator.









Make sure Windows version before installation.

Header folders include head file for software developer or System Integration.

Manual folders include API description.

Sample folders include sample program, driver library, and API library for Windows/Linux

Source folders include sample program source code that compile on Visual Studio 2008/ubuntu16.04.

-  Distribution
-  Header
-  Manual
-  Sample
-  Source
-  Uninstall\_32.bat
-  Uninstall\_64.bat
-  Win10\_32.bat
-  Win10\_64.bat

## A.3 Sample

Execute demo tool.

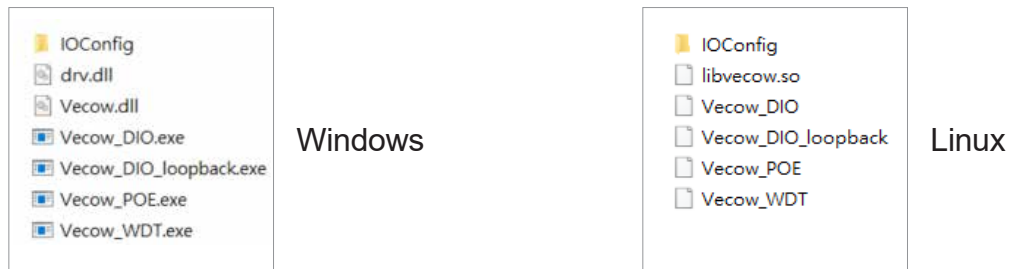

Sample, as shown below :

```
DIO sample version : v1.0.0609.0608
Load Vecow.dll at least v1.8.1409.0608
Vecow.dll Version : v1.8.1409.0608
Config : IO port I - Isolated DIO
         IO port II - Non-Isolated DIO(GPIO)

Choose IO : (1/2)
```

Vecow\_DIO

```
DIO loopback sample version : v1.0.1509.0608
Load Vecow.dll at least v1.8.1409.0608
Vecow.dll Version : v1.8.1409.0608
Config : IO port I - Isolated DIO
         IO port II - Non-Isolated DIO(GPIO)

How many IO temp_port : (1/2)
```

Vecow\_DIO\_loopback

```
POE sample version : v1.0.1609.0608
Load Vecow.dll at least v1.8.1409.0608
Vecow.dll Version : v1.8.1409.0608

Initial POE success!
Usable slave address ID : 0
Select slave address ID :
```

Vecow\_POE

```
WDT sample version : v1.0.0509.0608
Load Vecow.dll at least v1.8.1409.0608
Vecow.dll Version : v1.8.1409.0608
Config : IO port I - Isolated DIO
         IO port II - Non-Isolated DIO(GPIO)

Set WDT timer seconds (1~3932100) :
```

Vecow\_WDT

# B

## APPENDIX B : Software Functions

### B.1 Driver API Guide

In Header folder, Vecow.h and VecowLinux.h contain usable API for Windows/Linux.

#### **BOOL initial\_SIO(BYTE Isolate\_Type, BYTE DIO\_NPN)**

Initial machine for IO and watch dogtimer.

Isolate\_Type : DIO type.

1 : Isolated DIO;

0 : Non-Isolated DIO (GPIO).

DIO\_NPN : DI/DO type.

1 : PNP (Source) mode for European rule;

0 : NPN (Sink) mode for Japanese rule.

Return :

TRUE (1) : Success.

FALSE (0) : Fail (Driver not exists, or version is too old, or machine not match).

#### **BOOL get\_IO1\_configuration(BYTE \*Iso, BYTE \*DI\_mode, BYTE \*DO\_mode, WORD \*Mask)**

#### **BOOL get\_IO2\_configuration(BYTE \*Iso, BYTE \*DI\_mode, BYTE \*DO\_mode, WORD \*Mask)**

Get DIO configuration (by variable)

Isolate\_Type : DIO type.

1 : Isolated DIO;

0 : Non-Isolated DIO (GPIO).

DI\_mode ([7:0]) : DI type, pin setting by hexadecimal bitmask only for Isolated DIO.

0xFF : PNP (Source) mode for European rule;

0 : NPN (Sink) mode for Japanese rule.

DO\_mode : DO type only for Isolated DIO.

1 : PNP (Source) mode for European rule;

0 : NPN (Sink) mode for Japanese rule.

Mask ([15:0]) : In/Out, pin setting by hexadecimal bitmask only for Non-Isolated DIO (GPIO).

1 : Output;

0 : Input

Return :

TRUE (1) : Success.

FALSE (0) : Fail (Initial error, or call by pointer error, or hardware problem).

**BOOL set\_IO1\_configuration(BYTE Iso, BYTE DI\_mode, BYTE DO\_mode, WORD Mask)**

**BOOL set\_IO2\_configuration(BYTE Iso, BYTE DI\_mode, BYTE DO\_mode, WORD Mask)**

Set DIO configuration.

Isolate\_Type : DIO type.

1 : Isolated DIO;

0 : Non-Isolated DIO (GPIO).

DI\_mode ([7:0]) : DI type, pin setting by hexadecimal bitmask only for Isolated DIO.

0xFF : PNP (Source) mode for European rule;

0 : NPN (Sink) mode for Japanese rule.

DO\_mode : DO type only for Isolated DIO.

1 : PNP (Source) mode for European rule;

0 : NPN (Sink) mode for Japanese rule.

Mask ([15:0]) : In/Out, pin setting by hexadecimal bitmask only for Non-Isolated DIO (GPIO).

1 : Output;

0 : Input

Return :

TRUE (1) : Success.

FALSE (0) : Fail (Initial error or hardware problem).

**BOOL get\_DIO1(BYTE \*DO\_data, BYTE \*DI\_data)**

**BOOL get\_DIO2(BYTE \*DO\_data, BYTE \*DI\_data)**

Get isolated DIO output (DO) and input (DI).

DI ([7:0]) : Input state, pin setting by hexadecimal bitmask.

1 : High;

0 : Low.

DO ([7:0]) : Output state, pin setting by hexadecimal bitmask.

1 : High;

0 : Low.

Return :

TRUE (1) : Success.

FALSE (0) : Fail (Initial error or hardware problem).

FALSE (0) : Fail (Initial error or hardware problem).

**BOOL set\_DIO1(BYTE DO\_data)**

**BOOL set\_DIO2(BYTE DO\_data)**

Set isolated DIO output(DO).

DO ([7:0]) : Output state, pin setting by hexadecimal bitmask.

1 : High;

0 : Low.

Return :

TRUE (1) : Success.

FALSE (0) : Fail (Initial error or hardware problem).

FALSE (0) : Fail (Initial error or hardware problem).

**BOOL get\_GPIO1(WORD \*GPIO\_data)**

Get GPIO.

GPIO\_data ([15:0]) : GPIO state, pin setting by hexadecimal bitmask.  
1 : High;  
0 : Low.

Return :

TRUE (1) : Success.  
FALSE (0) : Fail (Initial error or hardware problem).

**BOOL set\_GPIO1(WORD GPIO\_data)**

Set GPIO.

GPIO\_data ([15:0]) : GPIO state, pin setting by hexadecimal bitmask.  
1 : High;  
0 : Low.

Return :

TRUE (1) : Success.  
FALSE (0) : Fail (Initial error or hardware problem).

**BOOL get\_WDT(DWORD \*WDT)**

Get watchdog timer setup.

WDT : watchdog timer setup.  
Unit : second (Range : 0 ~ 65535 sec, 1093 ~ 65535 min (=65580 ~ 3932100 sec)).

Return :

TRUE (1) : Success.  
FALSE (0) : Fail (Initial error, or call by pointer error, or hardware problem).

**BOOL set\_WDT(DWORD WDT)**

Set watchdog timer setup.

WDT : watchdog timer setup.  
Unit : second (Range : 0 ~ 65535 sec, 1093 ~ 65535 min (=65580 ~ 3932100 sec)).

Return :

TRUE (1) : Success.  
FALSE (0) : Fail (Initial error, or setup 0, or hardware problem).

**BOOL cancel\_WDT()**

Cancel watchdog timer.

Return :

TRUE (1) : Success.  
FALSE (0) : Fail (Initial error or hardware problem).

# C

## APPENDIX C : RAID Functions

The 11th Generation Intel processors (Intel Tiger Lake) utilizes the new Intel Volume Management Device technology, which optimizes the storage devices' data processing effectiveness and power consumption.

When you install Windows 10 retail or enterprise version, both need to load the IRST driver so Windows can detect a storage drive.

The steps below are required to set up and configure HW/BIOS supported systems for Intel® RST storage management through Intel® VMD. This is only a reference for system vendors and expert users. You also can refer to [the statement of Intel](#).

### C.1 Access BIOS Settings

1. Boot the system and press the Delete key as soon as you see the AMI BIOS Logo to enter the BIOS setup.
2. Chipset → System Agent (SA) Configuration → VMD setup menu



### 3. VDM Configuration

- a) Change the setting on "Enable VMD controller" to Enabled
- b) Change the setting on "Enable VMD Global Mapping" to Enabled



4. Save Changes and Reset. When asked if you want to save changes, click "Yes".

5. Access BIOS menu again, select Intel(R) Rapid Storage Technology.

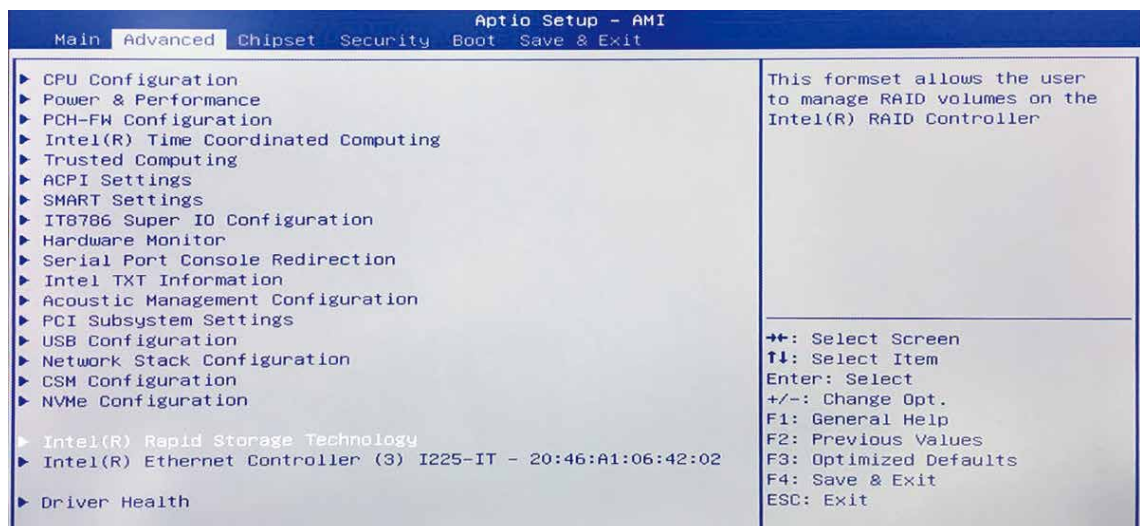

6. Select Create RAID Volume on BIOS menu.

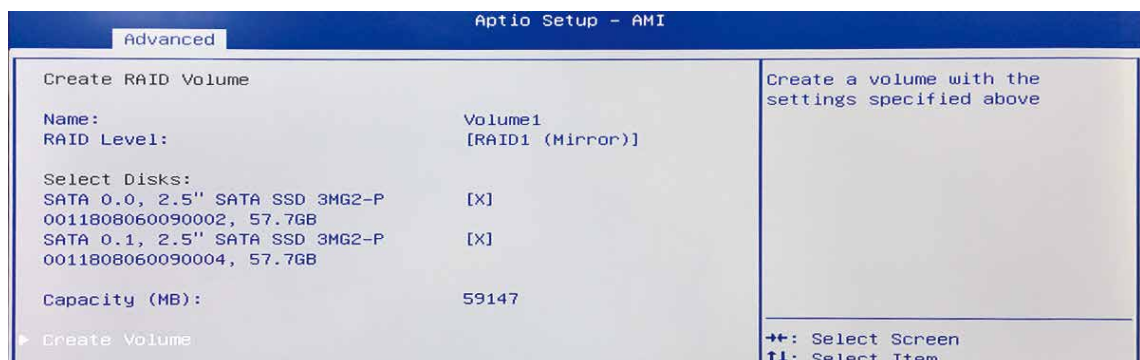

7. Select disks to create RAID Volume then Save Changes and Reset to install OS with UEFI mode.



## C.2 OS Installation

The system is featured with three SATA, include two internal SATA, and one M.2 Key B (3052) storage.

We take two SATA for Windows 10 OS installation as an example.

1. Please download "Intel Rapid Storage Technology (IRST) driver", Download Link from Intel website. [Intel® Rapid Storage Technology Driver Installation Software with Intel® Optane™ Memory](#)

2. After downloading the driver, right-click [F6flpy-x64 (Intel® VMD).zip] compressed file and select [Extract All].

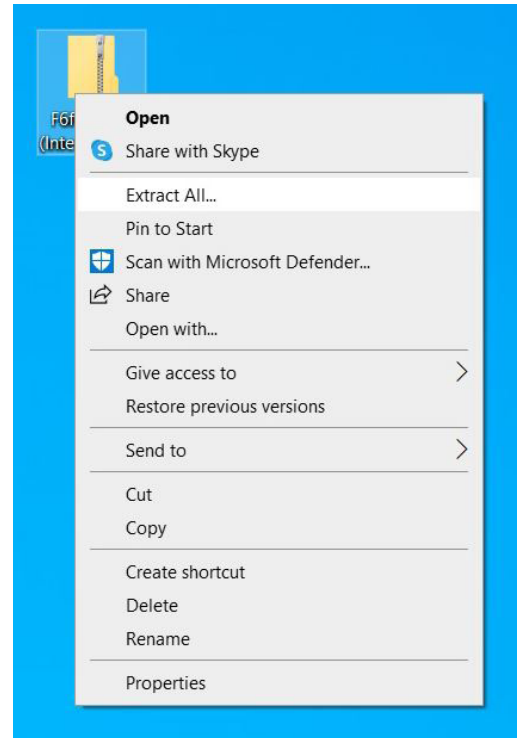

3. Unzip the file you download and save the files to the Windows 10 USB drive you created.

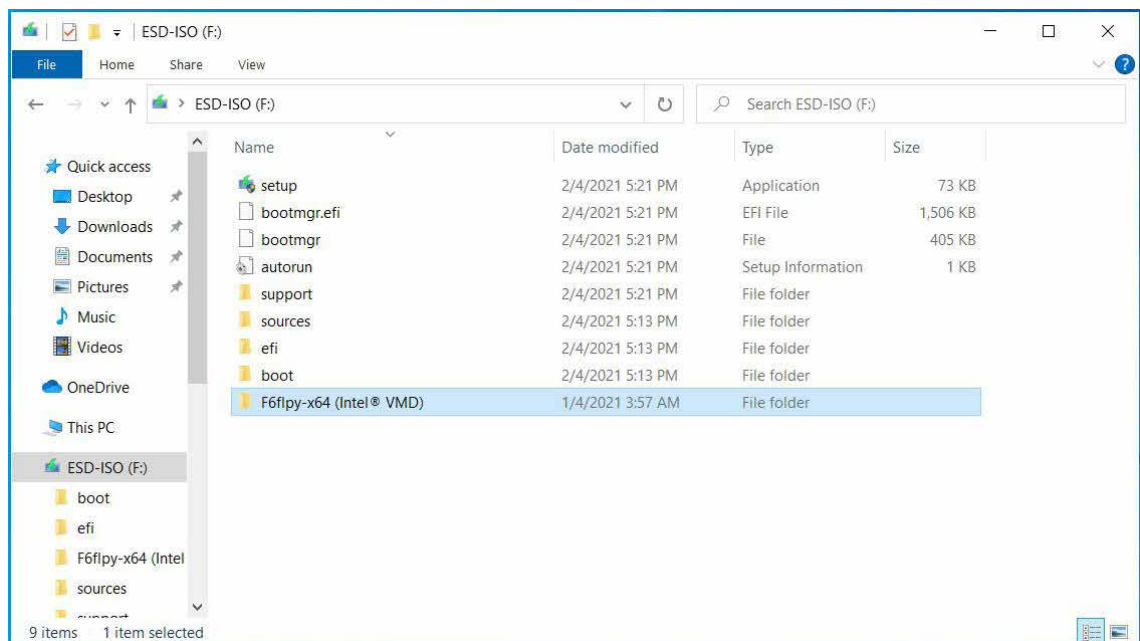

4. After the copying is completed, make sure the folder includes the following files.

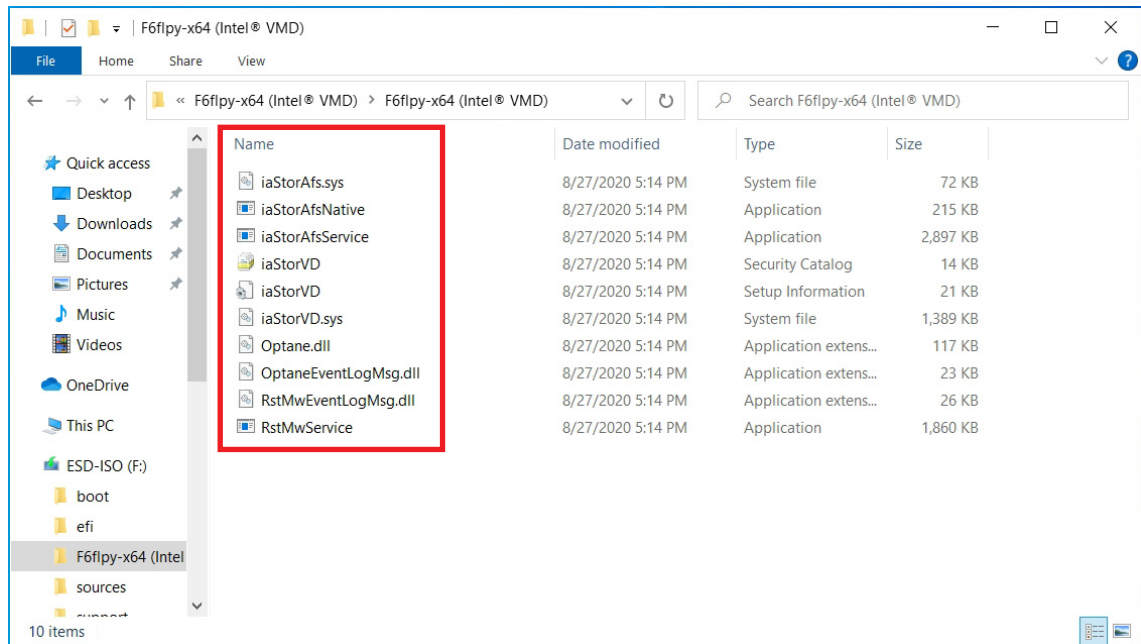

5. Select Windows 10 USB drive to enter Windows 10 setup interface Follow the installation instruction, the system should enter the storage setting interface, the bottom of the screen should display a message "We couldn't find any drives. To get a storage driver, click Load driver."

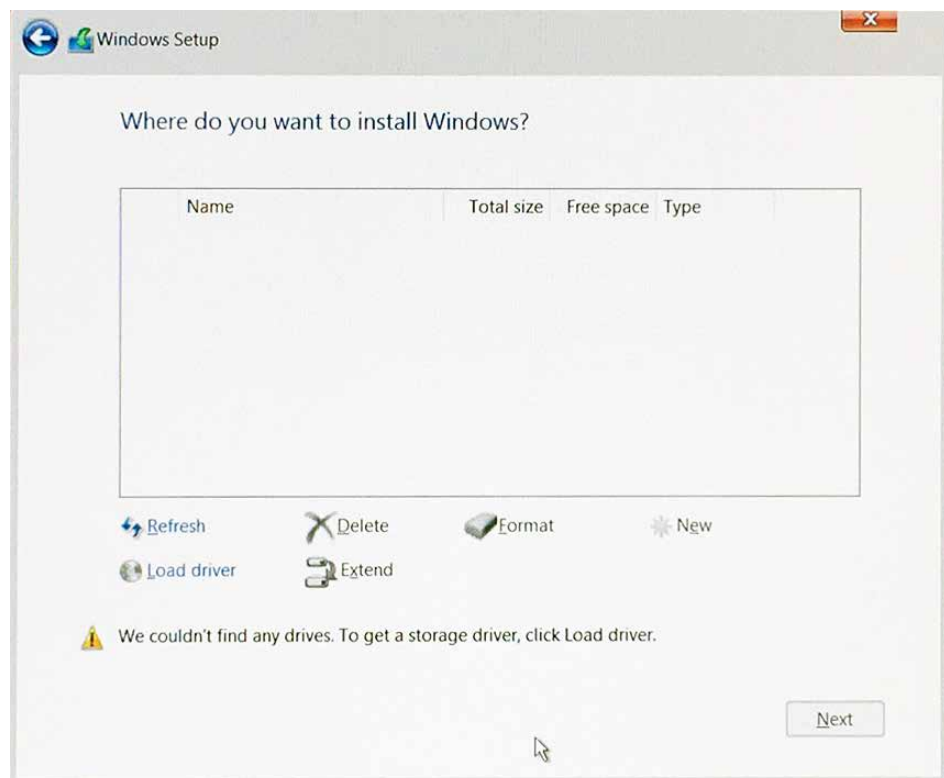

6. Click on Browse icon.

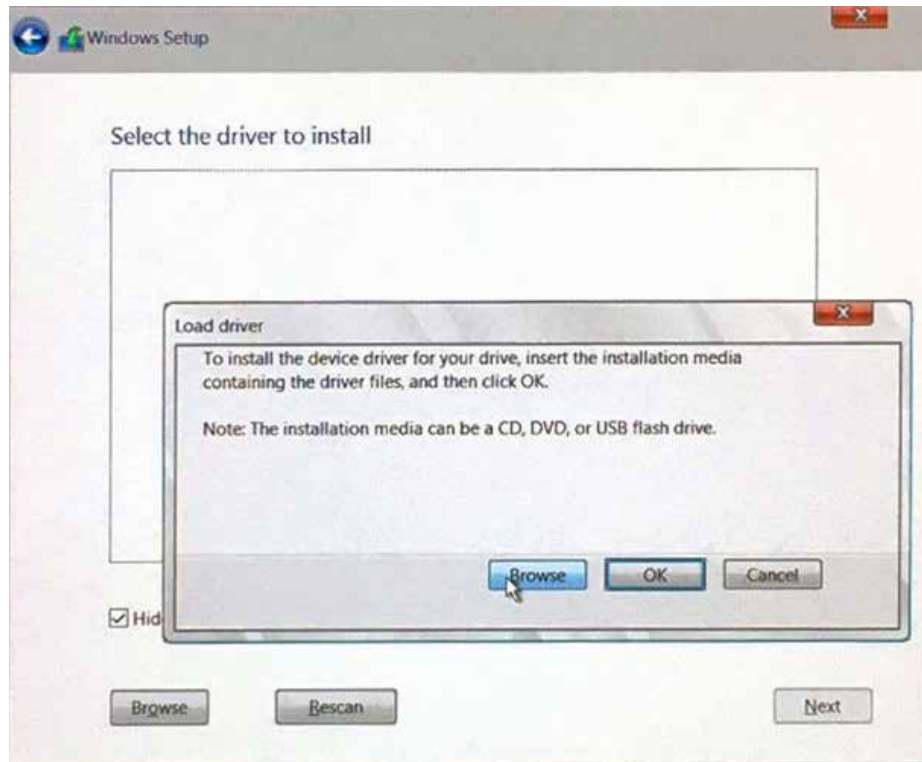

7. Select Intel VMD driver folder which has been saved in, then click on OK to continue the process.

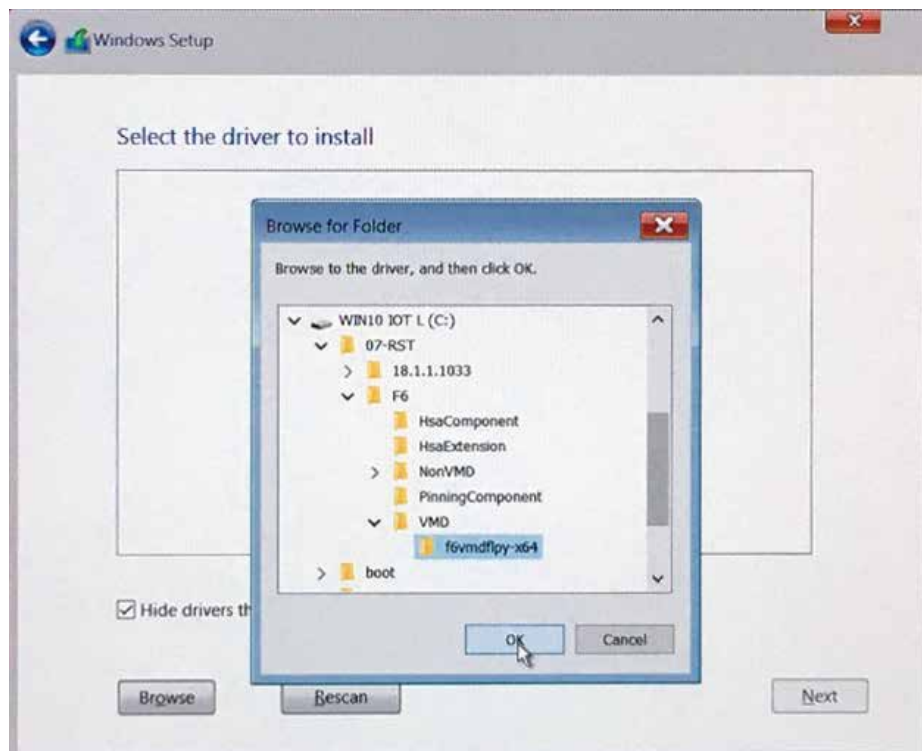

8. Select the top driver, and then click on Next button to continue the process.

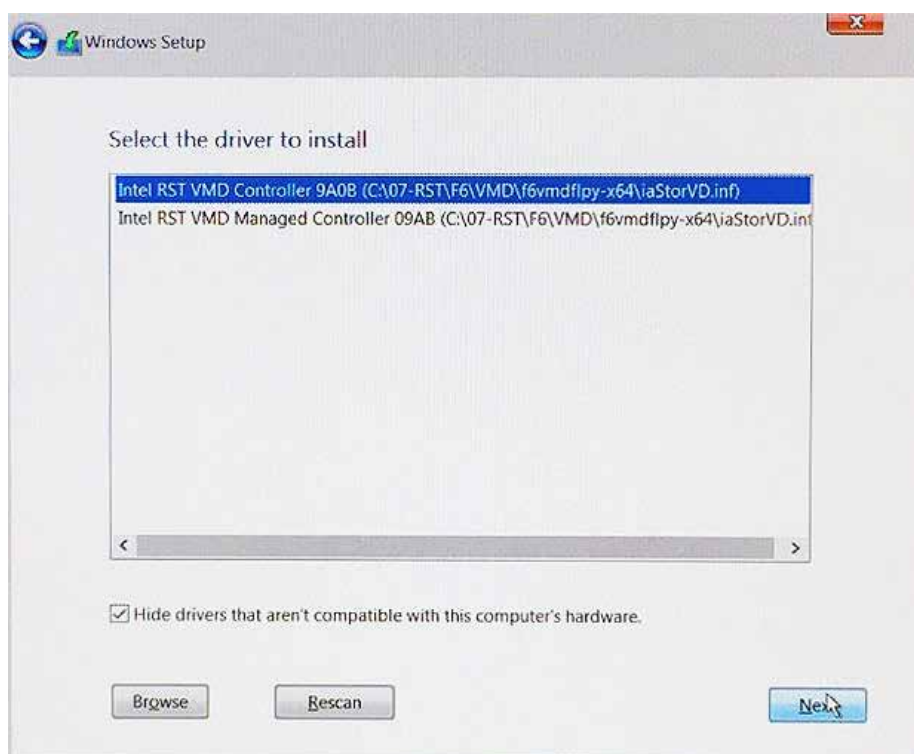

9. Windows 10 OS will automatically install the Intel VMD driver, after the process is complete, you will see the list of all drives and partitions on your computer. You can choose to "Refresh", "Format", "Delete" the available drives then click on Next to continue the Windows 10 installation process.



Note : This issue should be resolved in Windows 10 ver. 20H2, which will include the Tiger Lake IRST driver.

## **C.3 To Install All Device Drivers of the System**

The instructions are as follows :

1. To install Chipset driver
2. To install Graphics driver
3. To install ME driver
4. To install SerialIO driver
5. To install Network driver
6. To install Audio driver
7. To install Intel® Rapid Storage Technology Driver Installation Software with Intel® Optane™ Memory driver

## **C.4 To Install "Intel® Rapid Storage Technology Driver Installation Software with Intel® Optane™ Memory"Software**

You can get the software on the driver CD.

Also, you can find the latest information and software directly from Intel website.

<https://www.intel.com/content/www/us/en/support/products/99745/memory-and-storage/intel-optane-memory.html>

The RAID environment has been done if you completed the steps above.

## **C.5 To Insert SATA HDD/SSD for RAID 1**

Please notice, you can use two SATA ports for SATA storage devices.

## C.6 To get Intel® Optane™ Memory and Storage Management application

The Intel® Optane™ Memory and Storage Management application/user interface is a Microsoft Store\* app. It provides users with monitoring and management capabilities for the Intel® Rapid Storage Technology (Intel® RST) storage subsystem, [Download Link](#).

Note : The Intel® RST Driver is required to be installed before installing the application, read more [here](#).

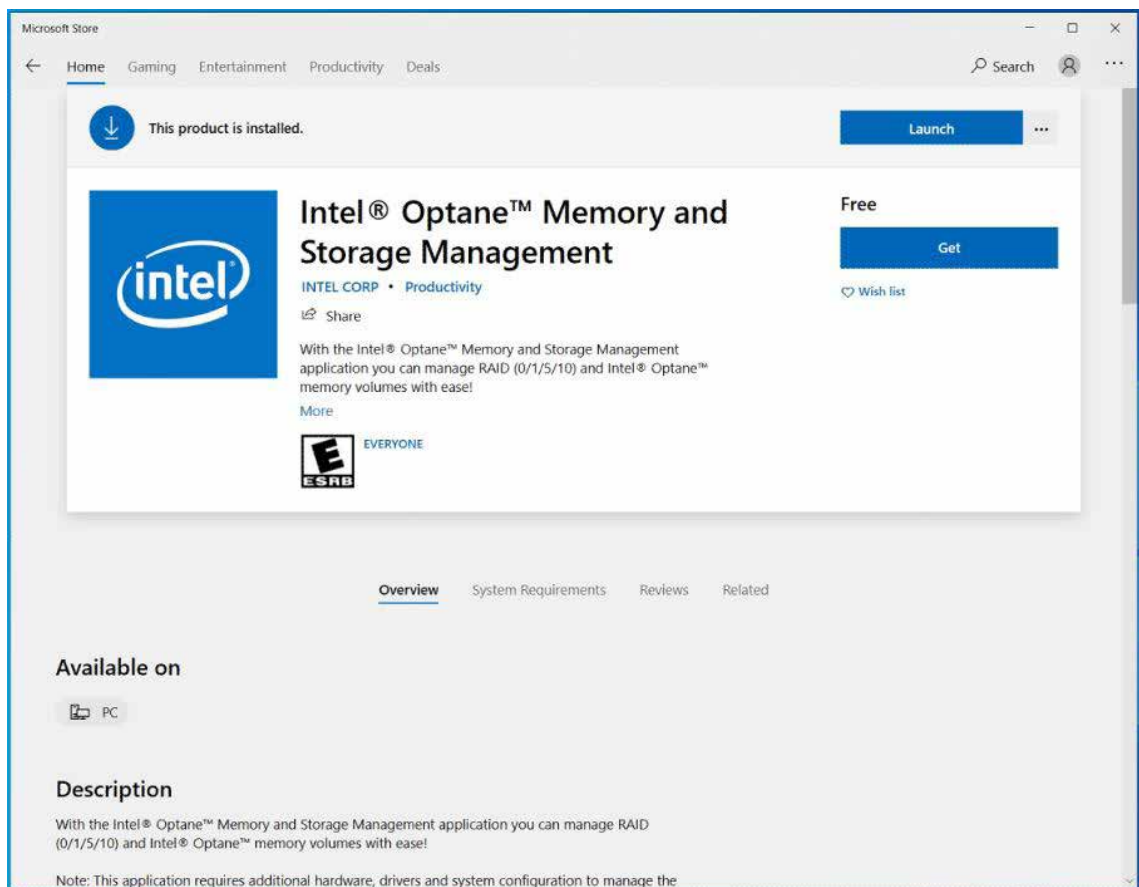

## C.7 Intel® Optane™ Memory and Storage Management User Interface

The volume will be shown in the OS-related applications, and it will display Pass-through SATA and PCIe disks, Empty SATA ports, RAID volumes, and Intel® Optane™ memory volumes.

The following guide link can assist you when managing Intel® Optane™ memory devices.

[Intel® Optane™ Memory Installation and User Guide](#)

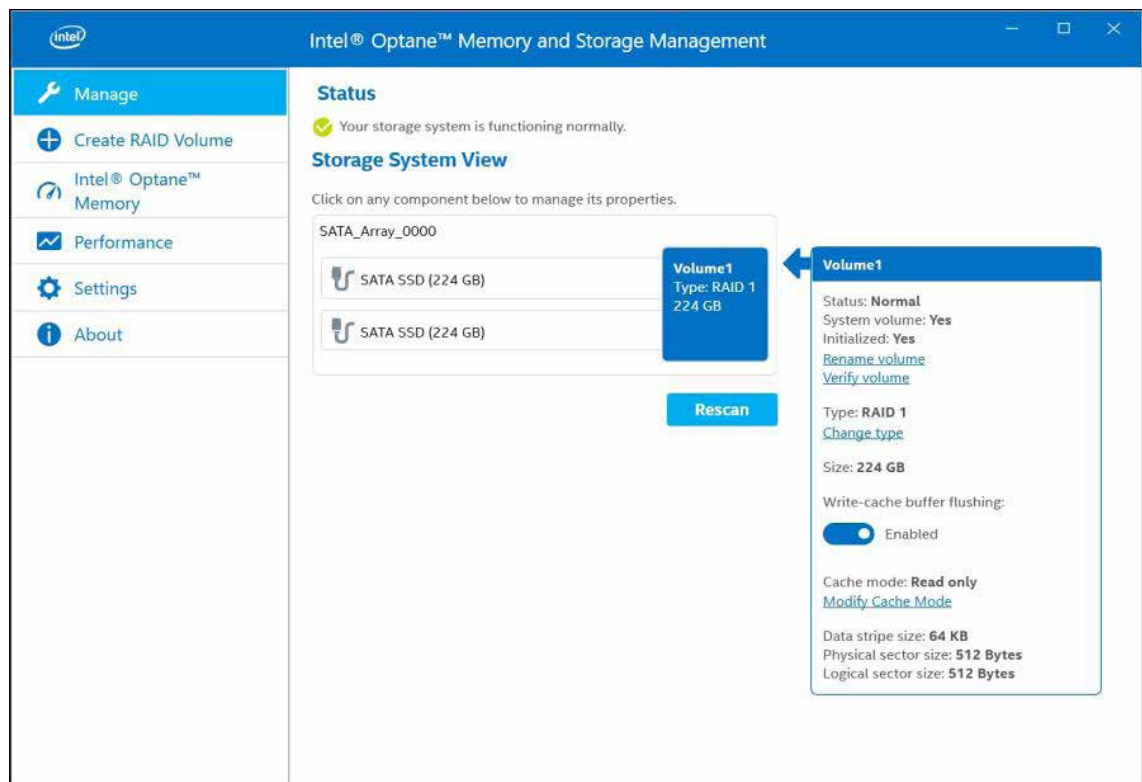



## C.8 If one of the hard drives has failed and needs to be replaced

The Intel application will have a screen that indicates the status of the member drives and will let you know which port has the failed drive.

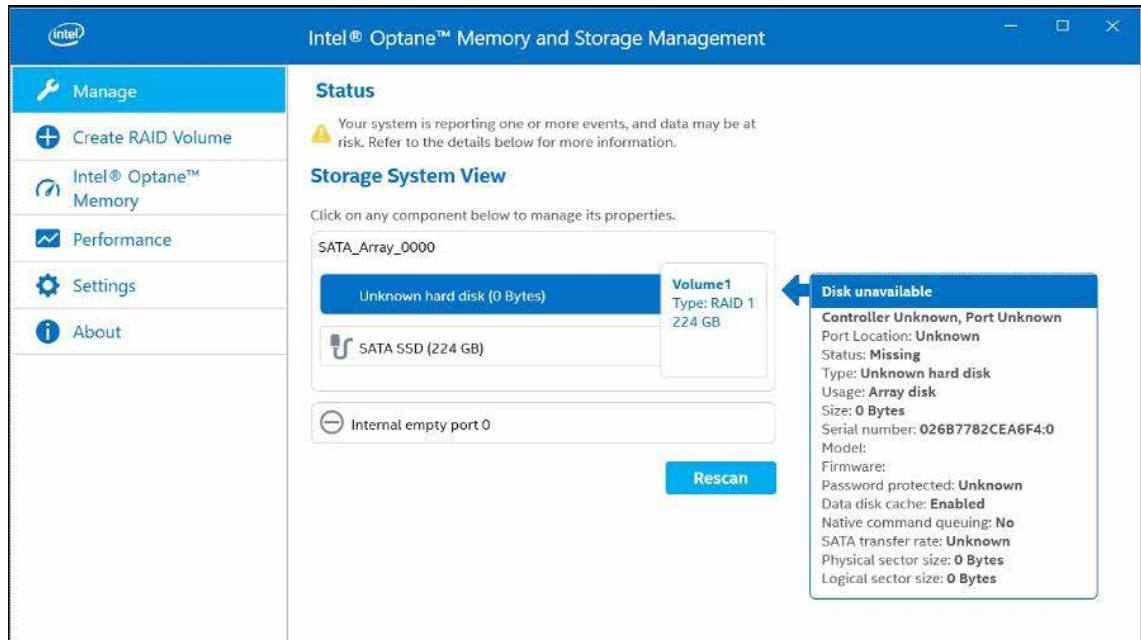

## C.9 Recovery and Auto Rebuild When Use the SAME RAID HDD/SSD

Open the Intel® Optane™ Memory and Storage Management User Interface to start will automatically rebuild a RAID volume after replacing the failed hard drive with a new hard drive of equal or larger size. This can take 1 - 3 hours to complete.

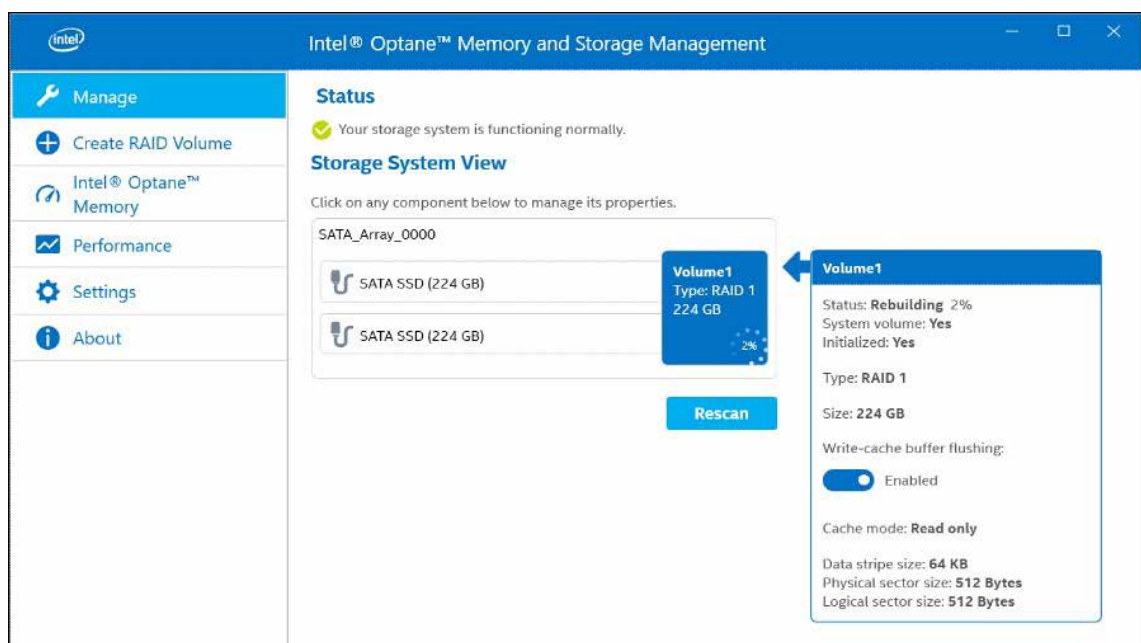



# D

## APPENDIX D : Power Consumption

### D.1 SPC-7000/7100/7200

Testing Board :	SPC-7000/7100/7200
RAM	32GB * 1
USB-1 : (USB 2.0)	USB Microsoft Wired Keyboard 600
USB-2 : (USB 2.0)	USB Mouse HP G1K28AA
USB-3 : (USB 3.0)	USB Flash ADATA 3.0 16GB
USB-4 : (USB 3.0)	USB Flash ADATA 3.0 16GB
USB-5 : (USB 2.0)	USB Flash Kingston 3.0 16GB
USB-6 : (USB 2.0)	USB Flash Kingston 3.0 16GB
SATA 0	Transcend SATA SSD420 128GB
SATA 1	Seagate HDD 500GB
LAN 1 (i219)	1.0Gbps
LAN 2 (i225)	1.0Gbps
Graphics Output	DP
Power Plan	Balance (Windows10 Power plan)
Power Source	Chroma 62006P-100-25

## D.1.1 Intel® Core™ i7-1185G7E 2.8GHz (12M Cache, up to 4.40GHz)

CPU	Power Input	Standby Mode		Power on and boot to Win 10 (64-bit)			
		Max Current	Max Consumption	Sleep Mode		idle status CPU usage less 3%	
				Max Current	Max Consumption	Max Current	Max Consumption
Core™ i7-1185G7E	9V	0.380A	03.42W	0.399A	03.59W	1.870A	16.83W
	12V	0.328A	03.94W	0.317A	03.81W	1.575A	18.90W
	24V	0.167A	04.00W	0.207A	04.96W	0.779A	18.69W
	55V	0.116A	06.36W	0.144A	07.93W	0.409A	22.50W

CPU	Power Input	Power on and boot to Win10 (64-bit)			
		Run 100% CPU usage with 2D		Run 100% CPU usage with 3D	
		Max Current	Max Consumption	Max Current	Max Consumption
Core™ i7-1185G7E	9V	3.345A	30.10W	3.863A	34.77W
	12V	2.452A	29.42W	2.429A	29.15W
	24V	1.269A	30.46W	1.320A	31.68W
	55V	0.617A	33.91W	0.634A	34.88W

## D.1.2 Intel® Core™ i5-1145G7E 2.6GHz (8M Cache, up to 4.10GHz)

CPU	Power Input	Standby Mode		Power on and boot to Win 10 (64-bit)			
				Sleep Mode		idle status CPU usage less 3%	
		Max Current	Max Consumption	Max Current	Max Consumption	Max Current	Max Consumption
Core™ i5-1145G7E	9V	0.300A	02.70W	0.423A	03.81W	2.077A	18.69W
	12V	0.236A	02.83W	0.334A	04.01W	1.508A	18.10W
	24V	0.155A	03.73W	0.217A	05.21W	0.772A	18.52W
	55V	0.126A	06.91W	0.145A	07.96W	0.398A	21.90W

CPU	Power Input	Power on and boot to Win10 (64-bit)			
		Run 100% CPU usage with 2D		Run 100% CPU usage with 3D	
		Max Current	Max Consumption	Max Current	Max Consumption
Core™ i5-1145G7E	9V	3.141A	28.27W	3.271A	29.44W
	12V	2.221A	26.66W	2.320A	27.84W
	24V	1.228A	29.47W	1.190A	28.57W
	55V	0.560A	30.79W	0.628A	34.53W

# E

## APPENDIX E : Supported Memory & Storage List

### E.1 Test Item

Testing Board	SPC-7000/7100/7200
Memory Test	MemTest86 V8.2
BurnIn Test	BurnInTest Pro V8.1 (build 1025)

Channel	Memory Test	Burn-in Test	Flash BIOS	Remove Battery	Sleep	Hibernate	Reset	CPU-Z
*1 (DIMM 1)	PASS	PASS	PASS	PASS	PASS	PASS	PASS	PASS

### E.2 Supported Non-ECC Memory List

Brand	Info	Test Temp.(Celsius)
innodisk 32G DDR4-3200 SO-DIMM	M4S0-BGS2OCEM-H03	25°C
innodisk 32G DDR4-3200 SO-DIMM	M4S0-BGS2O5EM-H03	25°C
innodisk 16G DDR4-3200 SO-DIMM	M4S0-AGS1O5EM-H03	25°C
SL-Link 16GB DDR4-3200 SODIMM	J4AGSH1G8TMFC	25°C
SL-Link 32GB DDR4-3200 SODIMM	J4BGSH2G8TMFC	25°C
SL-Link 8GB DDR4-3200 SODIMM	J4AGSH1G8TMEC	25°C
innodisk 16GB DDR4-2666 SODIMM	M4S0-AGS1O5IK-H03	25°C
SL-Link 16GB DDR4-2666 SODIMM	J4AGSH1G8QHFC	25°C
SL-Link 32GB DDR4-2666 SODIMM	J4BGSS2G8QHXI	25°C

## E.3 Supported Storage List

Type	Brand	Model	Capacity
M.2 SSD	innodisk	M.2 (P42) 3TE6	256GB
SATA SSD	Transcend	SSD370 TS64GSSD370	64GB
	innodisk	3MG2-P DGS25-64GD81BC1QC	64GB
		3TE7 DES25-B56DK1GC3QL-H03	256GB
	Kingston	SA400S371120G	120GB
		SUV400S37	120GB
	Intel	SSD E 5400s SSDSC2KR120H6	120GB
	MEMXPRO	M3A MI3MA1212802WN	128GB
	FORESEE	S903S128G	128GB
	FORESEE	S903S256G	256GB
	LITE-ON	K8-L1256	256GB
	LITE-ON	K8-L1512	512GB



For further support information, please visit [www.vecow.com](http://www.vecow.com)

This document is released for reference purpose only.

All product offerings and specifications are subject to change without prior notice.

No part of this publication may be reproduced in any form or by any means, electric, photocopying, or recording, without prior authorization from the publisher.

The rights of all the brand names, product names, and trademarks belong to their respective owners.

© Vecow Co., Ltd. 2024. All rights reserved.